

CHEAPER TELEVISION — THE SMALL-SCREEN RECEIVERS

Television

and *SHORT-WAVE WORLD*

OCTOBER, 1937

No. 116. Vol. x.

1/-
MONTHLY

Easily Built Unit by Unit
Cheapest Yet Possible
Range Tested up to 65 Miles



Clear, Bright, Steady Pictures
Very Simple Operation
Standard Valves and
Components

**LOW-
COST
TELE-
VISOR**

**FOR YOU
TO BUILD
AT
HOME**

BERNARD JONES PUBLICATIONS LTD.
CHANSITOR HOUSE, CHANCERY LANE
LONDON W.C.2.

THE FIRST TELEVISION JOURNAL IN THE WORLD

TELEVISION

and SHORT-WAVE WORLD

Special Features

Philips Projection Receiver	581
New Low-cost Televisor for Easy Home Construction	582
The Small-screen Receiver	590
The Televising of Films	594
Miniature Television	599
Baird Scanning Equipment	601
Radio Link	604
High-gain T.R.F. Receiver	613
Short-wave Radio World	617
23-watt Resistance-coupled Amplifier	620
New Valves for Television and Short-wave Constructors	626
The Amateur & Broadcast Interference	632
Johnson Q. Antenna	634

TELEVISION AND SHORT-WAVE WORLD

Proprietors :
BERNARD JONES PUBLICATIONS, LTD.

Editor-in-Chief :
BERNARD E. JONES.

Editor :
H. CORBISHLEY.
Editorial, Advertising and Publishing Offices :

Chansitor House, 38, Chancery Lane,
London, W.C.2.

Telephones : Holborn 6158, 6159.
Telegrams : Beejapee, Holb., London.

Subscription Rates : Post paid to any part of the world—3 months, 3/6; 6 months, 6/9; 12 months, 13/6.

Published Monthly—1/- net.
(Last Wednesday in every month for following month.)

Contributions are invited and will be promptly considered. Correspondence should be addressed according to its nature, to the Editor, the Advertisement Manager, or the Publisher, "Television and Short-wave World," Chansitor House, Chancery Lane, London, W.C.2.

IMPORTANT

"Television and Short-wave World" is registered at the General Post Office, London, for transmission to Canada and Newfoundland by Magazine Post. Entered as Second-class mail matter, Boston, Mass.

COMMENT OF THE MONTH

An Opportunity for the Amateur

IN this issue we place before our readers the design of a vision receiver in which the requirements of the amateur constructor, both as regards cost and ease of construction, have been prime considerations without, however, any sacrifice of performance. This last feature was deemed to be of such importance that the objectives aimed at can be said to be above the average, particularly as regards range. The design is by Mr. S. West and represents several months careful research.

It can definitely be said that the method of construction is the simplest yet attained. Each stage is practically separate and the constructor therefore has no complicated assembly to make, for the receiver consists of a number of units each of which entails only a fraction of the amount of work involved in a one-valve broadcast set. By careful design it has also been possible to obviate any necessity for elaborate lining up when the assembly is complete, so any amateur of ordinary ability can undertake the work with the assurance that the receiver will give excellent results upon completion. We guarantee that the design is practical and sound.

Cost is an important consideration in amateur receiver construction and it is dependent to a great extent upon the builder. In the present instance we give alternatives both as regards picture size and range and these will, of course, have a bearing on the cost. Fundamentally, the design for each alternative remains the same with certain modifications which will be detailed in the constructional articles. As all the components and valves are standard types many readers will be able to effect a saving by the use of existing components. Also no difficulty will be experienced in obtaining components. It is difficult to give a precise figure of cost, but we can give an indication by saying that in its entirety, constructed for long range reception, the cost, exclusive of tube and valves, is approximately £23, and as has been indicated above we are of the opinion that this figure can be materially reduced under some circumstances.

The complete televisor consists of three main units—vision receiver, time bases and power packs. In this issue we describe in detail the vision receiver, and next month particulars of the time bases and power packs will be given. These units have been considerably simplified and constructors will have no difficulty whatever in building them.

FIRST DETAILS OF THE PHILIPS PROJECTION RECEIVER

20-INCH PICTURES BY PROJECTION

ALTHOUGH several manufacturers of television receivers have been carrying out research in the design of cathode-ray projection receivers, the Phillips' receiver publicly demonstrated at Radiolympia is the first to be produced as a commercial article and its advent created something of a sensation. H.M.V. also showed a projection type receiver, but this and also the Phillips' receiver were removed early during the course of the exhibition and many visitors were disappointed in not being able to see them in operation.

In the new Philips' projection receiver the television image measuring 2 in. by 1.6 in. is formed on the end of a 4 in. cathode-ray tube and

filters in a voltage doubling circuit and the whole of the H.T. unit is entirely enclosed in a metal chamber with an interlocking door which breaks the supply voltage on being opened and earths the H.T. terminals of the condensers.

The television receiver is built up on three chassis which are bolted to a framework so constructed that the whole of the receiver can be removed from the cabinet for servicing.

The three units are:

- (1) The television sound and vision receiver and the synchronising amplifier.
- (2) The time bases for frame and line frequencies with the power pack for the amplifiers, but excluding

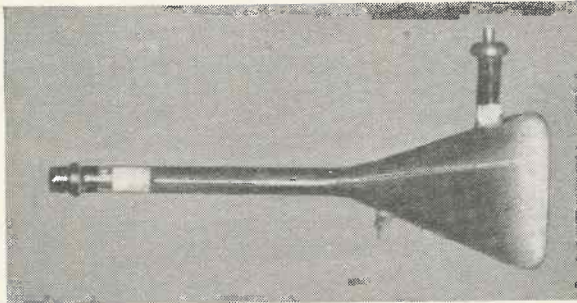

The tube used in the Philips receiver. The diameter of the tube at the large end is 4 inches and of this an area 2 in. by 1.6 in. is used for the picture.

is brilliant enough to be enlarged 100 times when projected via a 45° angle mirror in the inside of the lid of the cabinet on to a screen measuring 20 in. by 16 in.

The screen is incorporated in the cabinet and comes into view when the lid is raised. This screen is of the back projection type and is made on the 3-ply principle with the etched surface enclosed between two sheets of plain glass to prevent discolouration or soiling of the screen. A slow-motion device is provided to prevent damage to the screen by too rapid closing.

The cathode-ray tube has electromagnetic focusing and deflection and an H.T. voltage of 25,000 volts is used on the anode. This high voltage supply is provided by two H.T. recti-

the extra high tension supply.

- (3) The E.H.T. unit combining the H.T. transformer and condensers, also the cathode-ray tube compartment with the projector lens unit.

A broadcast receiver is included, but is separate from the television assembly frame and is similar to the standard 785AX type, a 5-valve high fidelity 3-waveband receiver with mono-knob control on the front of the cabinet.

The loudspeaker is mounted high up in the cabinet to give the impression that the sound accompaniment emanates from the screen.

Twenty-eight valves are used in the receiver, twenty-three for television and five for the broadcast set.

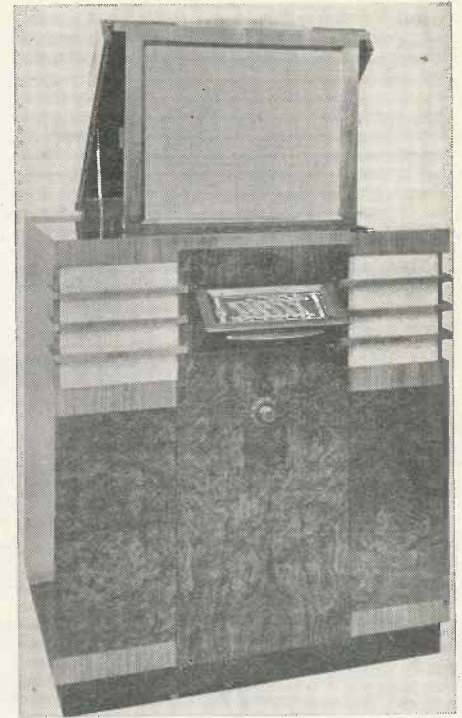

The Philips projection receiver which provides a picture 20 ins. by 16 ins.

The circuit of the television receiver commences with a radio-frequency amplifier with a TSP4 valve for both sound and vision. Separate triode-hexode frequency changers Type TH4A are used for sound and vision.

The sound is taken to a TSP4 I.F. amplifier on 7.6 Mc and then to a 2D4A for detection and A.V.C. From here the sound is fed into the pick-up sockets of the broadcast receiver and controlled for volume and quality by the mono-knob on the front of the cabinet.

The vision after the frequency changer goes to four stages of I.F. amplification on 11.1 Mc with TSP4 valves and then to a 2D4A for detection and a Pen A4 output pentode. A further diode is used to obtain the D.C. control for the cathode-ray tube.

The synchronising signal is taken from the output of the vision amplifier to a further TSP4 amplifier and a diode which supplies the synchronising impulses to the slow (frame) and fast (line) time bases.

The line frequency or fast time base employs four valves; a Pen A4 feeding two Pen 428 valves in parallel. The frame frequency or slow time base has two valves, a gas triode, type GT4H, feeding into a

(Continued at foot of page 589)

A NEW TELEVISOR FOR

MANY UNIQUE FEATURES:

Designed by

- **SIMPLE UNIT CONSTRUCTION**—Does not need special skill in its building.
- **LOW COST**—Cheapest televisor yet offered to the public.
- **STANDARD COMPONENTS**—Obtainable from stock.
- **STANDARD VALVES**—Stocked by most local dealers.

WHAT THE RECEIVER IS—

This televisor is the result of several months experimental work in the provision of a suitable design for amateur construction. Three vitally important points were kept in view—construction must be simple, cost must be low and components and valves must be of types easily obtainable. These objectives have been attained.

The instrument is a vision receiver only, consisting of three main units—receiver, time bases and power packs. Later it is proposed to describe a simple converter for attachment to any ordinary broadcast set for the reception of the television sound, or alternatively an all-wave broadcast receiver capable of tuning in the television sound can be used.

The receiver will be described in its completed form with three H.F. stages which have enabled excellent pictures to be obtained at a distance of 65

AS EASY TO BUILD AS A BROADCAST SET

THE design of a television receiver suitable for use at long range from the transmitter, although perfectly straightforward, is not without its difficulties when it is desired to make it possible for the average home constructor, with limited constructional facilities, easily to follow the design and build for himself with a minimum of difficulty a replica of the original model. This receiver was first designed for long-distance reception, and the very successful attain-

COMPONENTS AND VALVES

All components and valves used in this receiver are standard types which are readily obtainable from most wireless dealers. This is a great advantage as constructors are assured of being able to obtain supplies without any delay.

ment of this objective ensured that modifications could be made to render it very suitable for operation at lesser ranges also.

For long-distance reception quite high amplification is required, and this with a minimum of valves, which should preferably be normal types. Although it is possible to secure high R.F. efficiency from Acorn

valves, they are expensive and, due to their physical dimensions, awkward to wire into their holders.

There is, however, little object in using normal valves if the number required, together with their associated circuit components, exceed in cost an arrangement using Acorn valves.

Due to the heavy damping imposed by a normal R.F. pentode valve at frequencies around 45 mcs., it is possible to use two or three R.F. stages very lightly damped and to secure an excellent frequency response.

Two stages are very easily constructed, and it is by no means difficult to construct three. The overall gain given by two stages is a little higher than that obtainable from a single Acorn stage, as it is necessary slightly to detune an Acorn R.F. stage to secure adequate frequency response. But a big economy is effected by using normal valves.

Leaving this part of the receiver for a moment we will consider the I.F. amplifier.

The simplest form of coupling to employ here is undoubtedly the familiar tuned anode. Such couplings are cheap, simple to construct and adjust, and the necessary inductances can be simply wound by the home constructor.

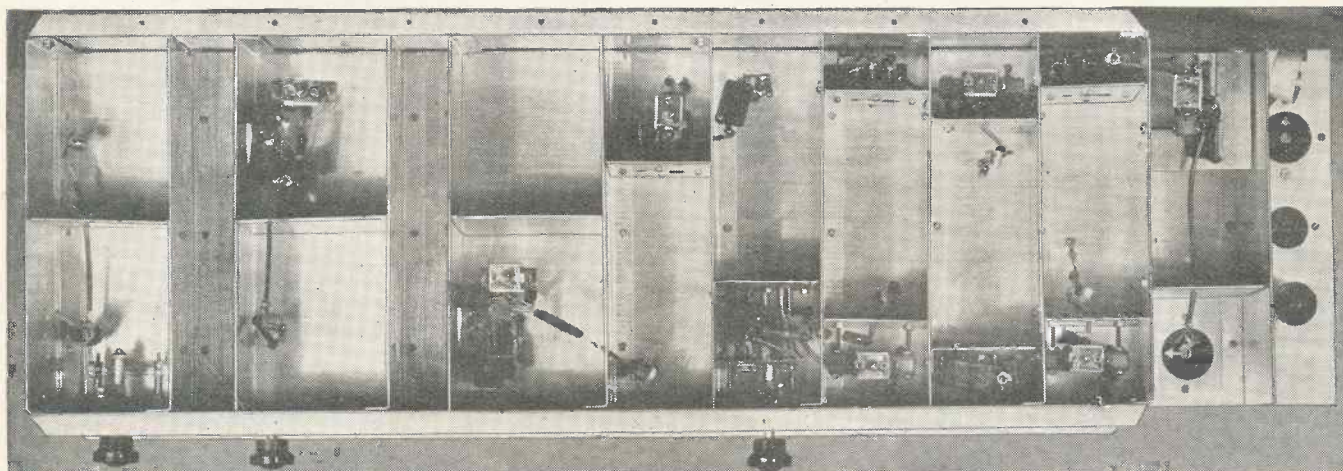

This plan view of the receiver shows how each stage is in a separate compartment, most of the components being secured to the aluminium dividing panels on which they can be assembled before the chassis is built up. Interstage connection is by means of the valves.

EASY HOME CONSTRUCTION

S. West

GUARANTEED PERFORMANCE:

AND WHAT IT WILL DO

miles. For shorter ranges the number of H.F. stages can be reduced and how this can be done will be clearly explained; this of course will result in a reduction of cost. In addition either a 10-in. or 7-in. cathode-ray tube can be employed.

The construction is just as simple as any ordinary wireless set and requires no special knowledge. Each stage is almost completely assembled and wired up on small aluminium panels which provide the screening; with this system it is practically impossible to make any error, especially as the stages are separately illustrated very clearly. In addition, lining up is of the simplest character and the time bases are very simple to adjust. The amateur constructor can have every confidence in his ability to build the receiver and get excellent pictures immediately.

- **THREE RANGES**—65, 35 and 20 miles according to number of stages.
- **AMPLE RESERVE OF POWER**—providing clear bright, and steady pictures.
- **NOVEL SYNCHRONISING SYSTEM**—Unaffected by local interference.
- **PRE-SET TUNING**—Ensuring simple operation.

CONSTRUCTED IN COMPLETE SIMPLE STAGES

This photograph shows the receiver, time base and tube housing and comprises the complete receiver with the exception of the power pack which is a separate unit. The entire chassis is built up of sheet aluminium and the only tools necessary for the construction are those ordinarily in the possession of the wireless amateur.

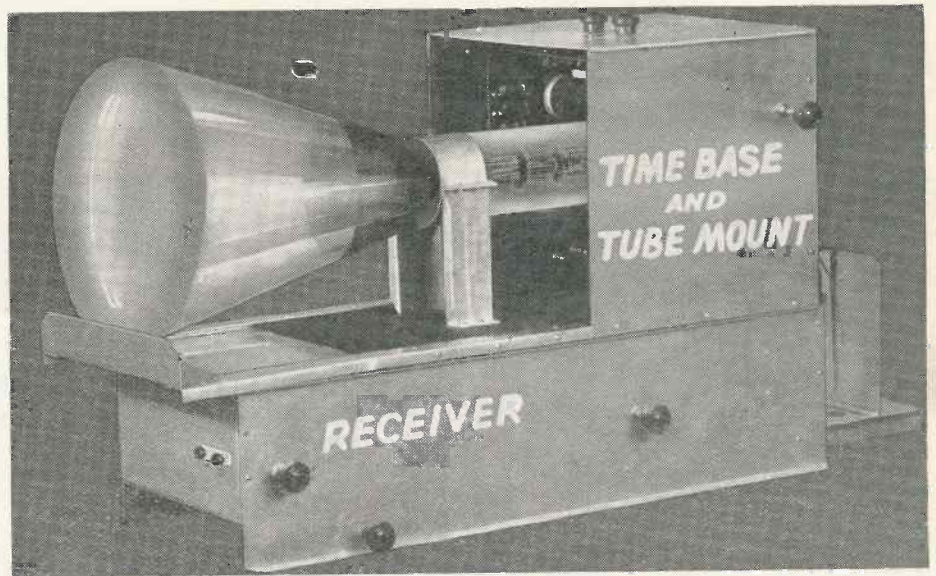

The scanning and synchronising systems employed in this televisor have been developed by Mr. Paul D. Tyers and are the subjects of applications for patents. Home constructors are, however, at liberty in building this televisor or having it built for them to use these inventions without any obligations whatever, but this permission does not, of course, extend to commercial interests which must make their own arrangements with Mr. Tyers, who, by the way, in a special article appearing on pages 609 and 610 of this issue explains his system in detail.

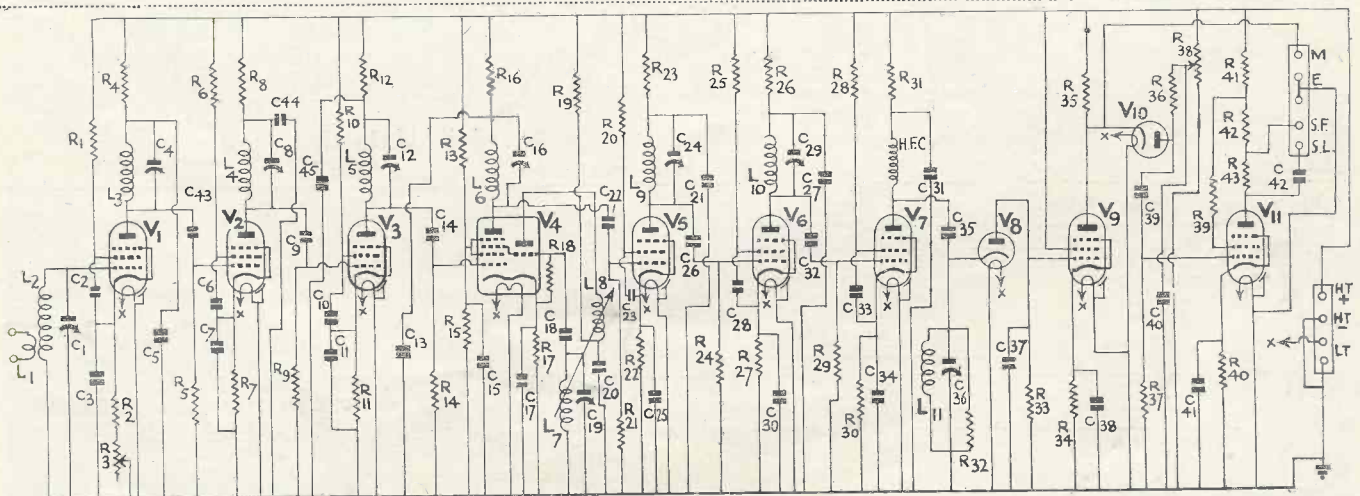

Although three R.F. stages and three I.F. stages are used in the Vision receiver, for Local reception two of the R.F. stages may be omitted and the damping on the I.F. stages may be reduced considerably. The frequency changer is a Triode-Hexode, while the second detector is a conventional low capacity Diode. With three R.F. stages and three I.F. stages, all Tuned Anode coupled, the heavy circuit damping customarily used to secure the wide frequency response necessary in Vision receivers is not required. It is, however, desirable to damp the I.F. stages more than the R.F. stages, as the damping imposed by the valves is very much lower at the I.F. frequency. Actually the I.F. stages are heavily damped as this considerably simplifies the initial adjustments.

DETAILS OF THE CHASSIS

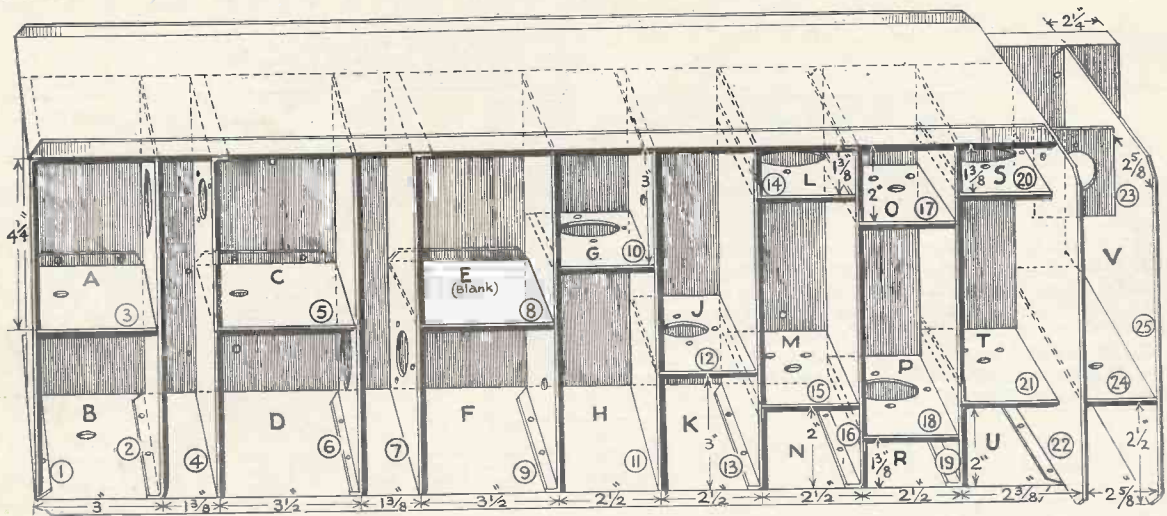

A perspective view of the chassis. The letters are for the purpose of cross reference to the stage details given on the following pages.

This drawing shows the parts required for the construction of the receiver chassis. It will be observed that in many cases these are duplicated. The various parts are held together by means of $\frac{1}{4}$ in. 6 B.A. screws and nuts which permit of easy assembly.

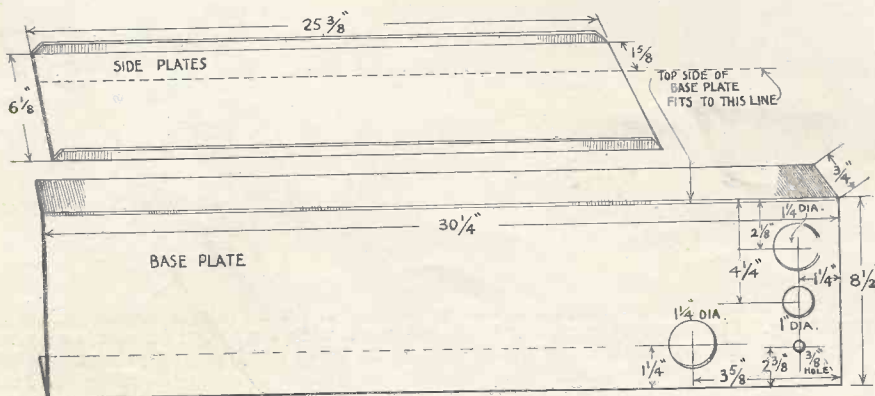
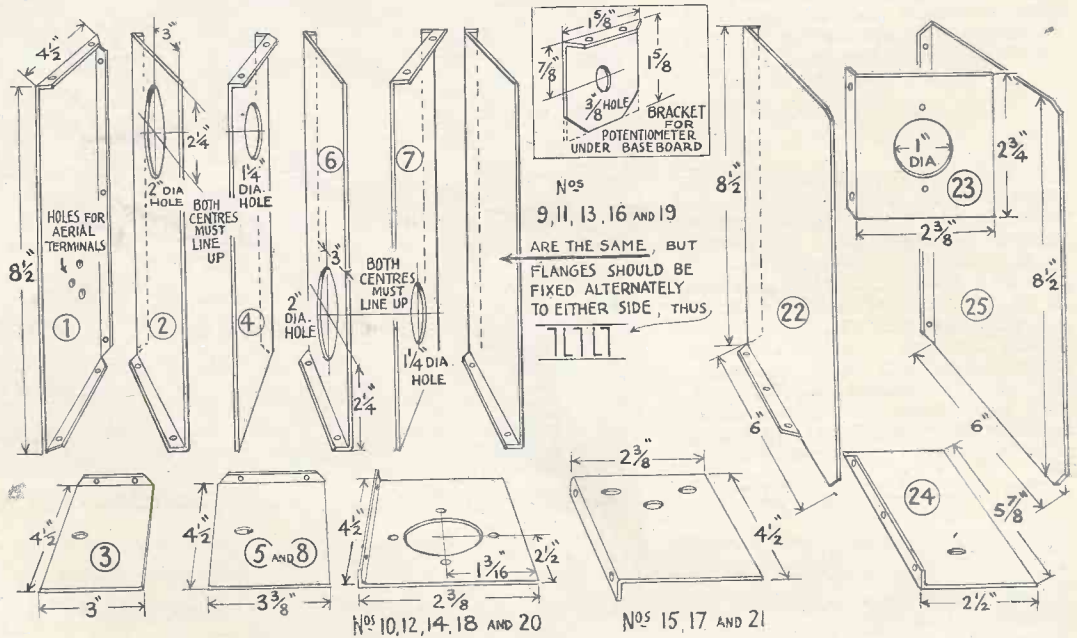

Here are details of the base and sides of the receiver chassis, the edges being turned at right angles for simple assembly.

DUPLICATED STAGES SIMPLIFY CONSTRUCTION

Unfortunately if good response is to be secured, theory indicates that heavy damping is required, and it can be shown that with the required damping for adequate frequency coverage the gain per stage is very

THE CHASSIS

The chassis of this receiver is constructed of 19-gauge aluminium and may be either home constructed or purchased ready made. The edges of the various parts can be turned up quite easily by using two pieces of angle iron in a vice. It should be noted that the screens are not secured at both ends, a feature which makes them very easy to fit as double alignment of fixing holes and exact adjustment of length is not necessary. Dimensioned drawings are given showing all the necessary particulars.

low. Happily there is a simple method of increasing the gain and at the same time retaining an excellent frequency characteristic.

It is well known that it is possible to obtain band-pass characteristics from a number of tuned stages by the simple expedient of staggering the tuning. The

gain secured is then higher than when the circuits are tuned to resonance for reasons which need not be mentioned here.

Three stages of I.F. amplification providing they can be persuaded to furnish sufficient amplification would, from the home constructor's point of view, be very desirable. Almost all possibility of instability disappears, and there are only four circuits to adjust.

It is common practice to use four and five I.F. stages, but in the writer's experience this is not desirable, especially for the home constructor. He has observed that in most cases with home-constructed gear stability is obtained by a quite drastic use of increased bias on one, and often two, stages.

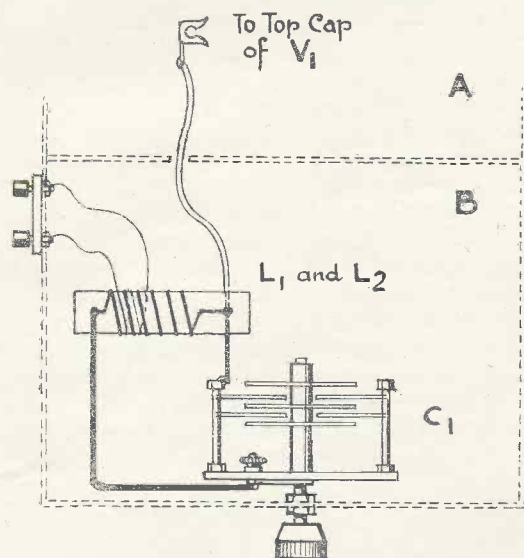

Wiring details of sections A and B, shown in the perspective view of the chassis.

Extended views are given of component assembly and wiring in order to make the drawings clear. As the space is restricted the assembly must be compact and leads kept short.

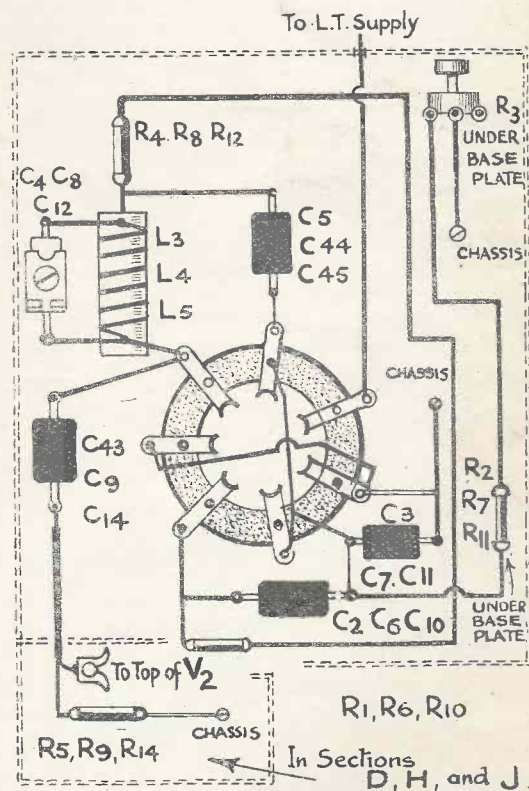

Wiring details of sections C, F, and G. Reference should be made to the circuit diagram for checking the connections.

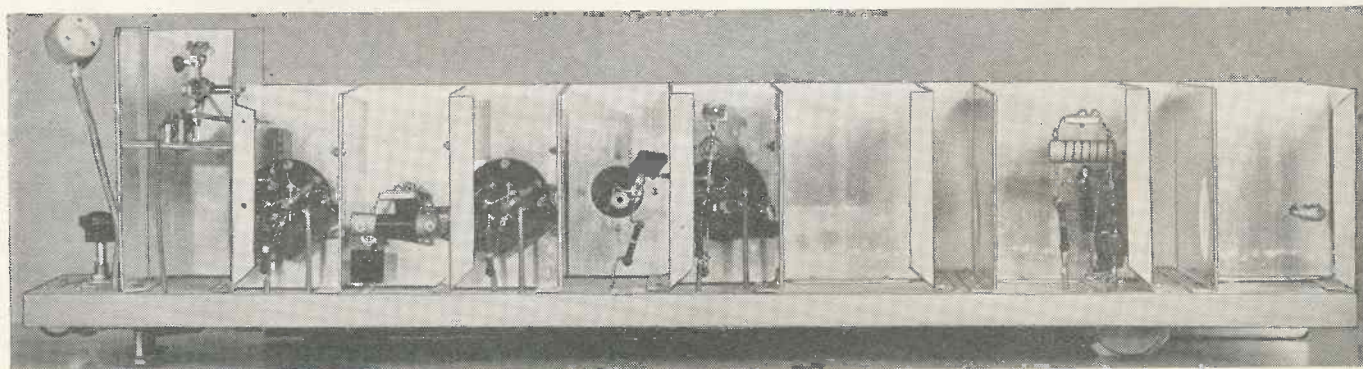

A photograph of the left-hand side of the receiver chassis showing the components in position. The simple construction will be apparent.

UNIT ASSEMBLY ON METAL PANELS

Let us then assume that we are to employ only three I.F. valves and see the form it will be necessary for the rest of the receiver to take. It is almost certain that we shall need a stage of V.F. amplification, perhaps two.

Now, while it is easy to obtain good results from one V.F. stage, two can be tricky, and a good deal of care must be taken with their layout, also decoupling must

ASSEMBLY OF COMPONENTS

The wiring and assembly of components are very simple as most of the work can be carried out before the chassis is finally assembled, leaving only one or two connections to be made on completion. The only compartment that is likely to present any difficulty is that containing the oscillator stage as this is somewhat crowded, but no trouble will be experienced if the connections are all cut to the correct length before soldering. Each stage should be checked before assembling in the chassis.

be very thorough. This does not accord with the requirements of our design, and in view of this we shall decide to use only a single stage.

So we have our design taking shape. We have either two or three R.F. stages, three I.F. stages and a stage of V.F. amplification. We are assuming the use of a triode-hexode frequency changer and a diode detector.

Tests were made with two R.F. stages, and although such an arrangement is capable of giving good pictures

up to about forty miles, the tests revealed that to ensure consistent results at greater distances a little more amplification was desirable.

Three R.F. stages employing normal valves are, as has been remarked, quite easy to construct, and very little artificial damping is required as that imposed by the valves is practically sufficient; with this number the signal is adequate even under the worst conditions.

Our final design for long range, therefore, becomes a receiver employing three R.F. stages, a triode-hexode frequency changer, a diode detector and one stage of V.F. amplification. We shall also need two further valves for synchronising. A new system is used here that is eminently suitable for television receivers operated under adverse conditions.

Tuned anode couplings are used in both the R.F. and I.F. sections. Single circuits are used in all cases, although it is appreciated that this is rather unusual practice. For that matter the whole design is rather unusual. The writer's only excuse for the arrangement, and in his opinion a very good one, is that it gives excellent results at long distances and under conditions where other arrangements have failed lamentably to provide good entertainment; also, throughout, the receiver has been considered with particular reference to its easy construction and adjustment by the home constructor.

As a matter of interest, extensive tests revealed no difference between this receiver and a more expensive arrangement using a similar number of valves, three of which were Acorns.

A brief word here in connection with the coils. If the constructional drawings showing these are referred to, it will be seen that their turn numbers vary. Care must be taken to use each coil in its correct position for only by so doing is the correct frequency response secured and the task of adjusting the circuits is considerably simplified. Indeed, it will probably be found that almost the only tuning required when the receiver is connected are adjustments to the oscillator and aerial condensers. Of the trimmers it will be found

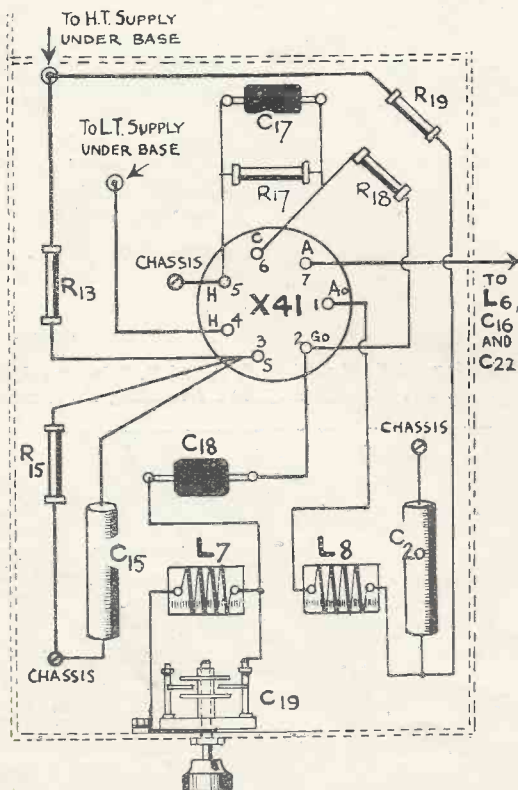

Wiring details of section K indicated in the perspective view of the chassis.

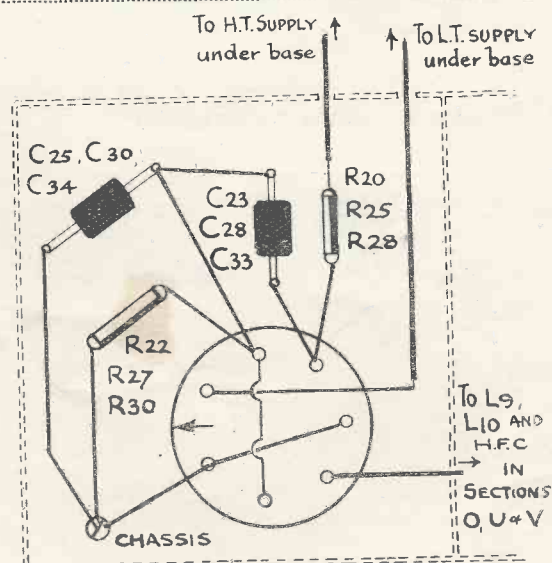

Wiring details of sections L, R, and S.

WIRING IS PARTICULARLY SIMPLE

that the most sensitive to adjustment is the one preceding the frequency trimmer and that preceding the diode, i.e., the last trimmer of the R.F. section and the last trimmer of the I.F. section.

No particular difficulties are presented in the construction of the receiver. It will be seen that almost the entire assembly of each stage can be made upon the aluminium panels which form the screens. This arrangement allows each to be checked and the possibility of error is very small.

The metal work is carried out in 19 gauge aluminium. The drawings give all dimensions and the photographs will make plain any point concerning which there may be doubt.

The wiring will not be found difficult if the following procedure is observed.

A start is made at the aerial end and each valve com-

partment is completed as far as possible before being bolted to the main chassis. The remaining connections are then easily made with a side removed. Before bolting the aerial end on, the first valve must be fitted as it is not possible to insert this afterwards.

A small point, but one worthy of attention, is to ensure that all connections to the chassis are well made. When bolting down soldering tags and compartment screening, it is well to ensure that clean surface contacts are made. Beware of dry joints, for there is nothing more annoying in an assembly of this description than to find oneself confronted with the task of dismantling half of it to reach a lead that has come adrift.

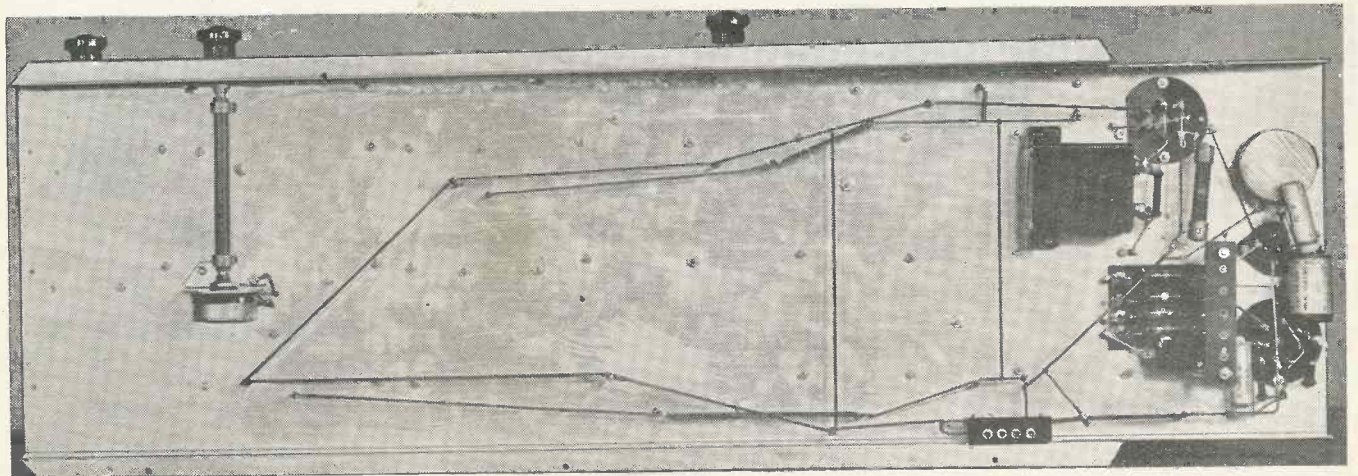
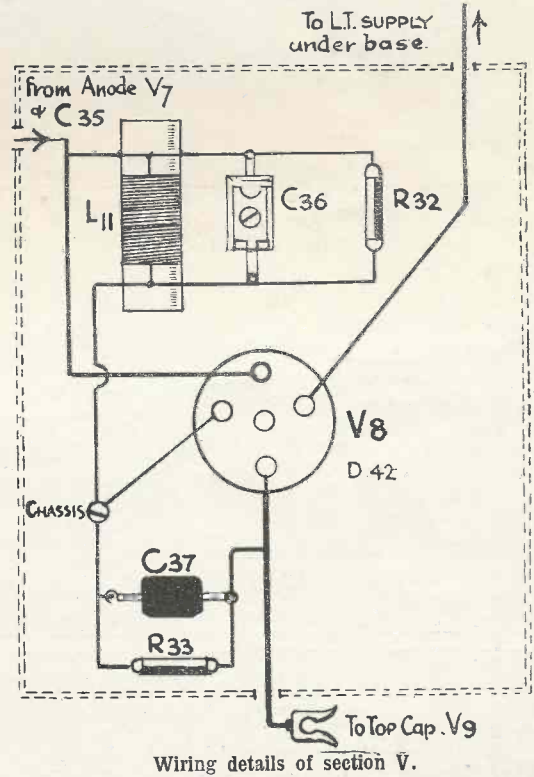
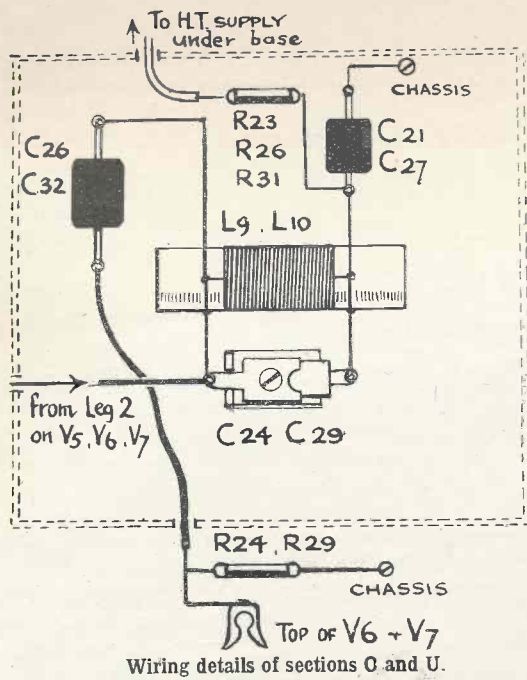

A photograph of the underside of receiver base. Very few components are used and exact details of the assembly and wiring are given on the next page.

SIMPLE COIL CONSTRUCTION IS A FEATURE

In the original receiver bare tinned wire was used throughout. Systoflex covering being used only where leads passed through the screening.

All leads should be kept as short as possible, and it is not advisable to depart from the original layout.

The R.F. inductances are supported by 16 s.w.g. tinned wire and this gauge can conveniently be used elsewhere where extra support is needed. It is essential

adjustment of their coupling should be allowed which can be made by slightly bending their supports.

There are advantages in using a comparatively high I.F. frequency, and no difficulties are encountered by so doing with only three stages. Consequently the I.F. inductances are quite small. These are mounted on short lengths of 4 or 6 B.A. rod and are then bolted to the screens.

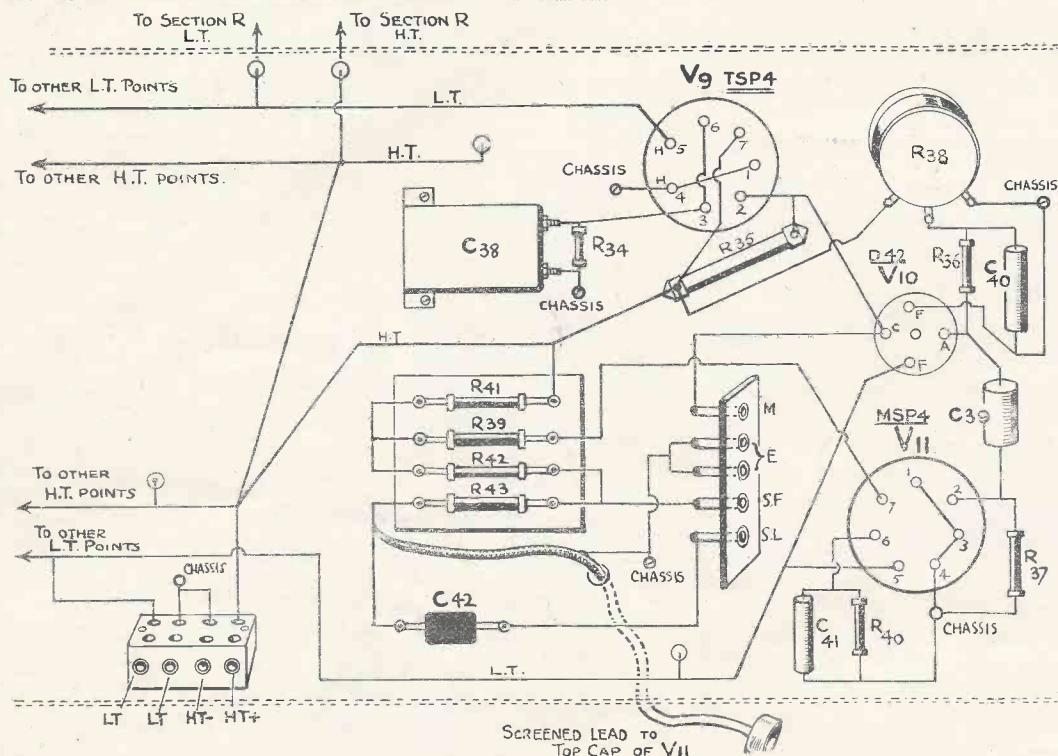

This diagram gives the necessary details of the component assembly and wiring on the underside of the receiver baseplate. Reference should be made to the photograph on the preceding page.

COIL DATA

The coils are of a very simple type and can be either purchased ready made or home constructed. Paxolin formers are employed and the coils are supported by B.A. studding provided with nuts to hold the coils in position. The coils up to 7 turns are wound approximately $\frac{1}{8}$ in. between turns and the remainder are close wound. The following is the data for the construction of the coils.

L1—2 turns 28 DSC at earth end of L2

- L2—6 turns 24 SWG enamel.
- L3—6 turns 24 SWG enamel.
- L4—6 turns 24 SWG enamel.
- L5—7 turns 24 SWG enamel.
- L6—55 turns 28 SWG enamel.
- L7—4 turns 18 SWG enamel.
- L8—4 turns 18 SWG enamel.
- L9—55 turns 28 SWG enamel.
- L10—55 turns 28 SWG enamel.
- L11—60 turns 28 SWG enamel.

FORMERS— $\frac{1}{2}$ in.—paxolin $1\frac{1}{8}$ -in. long.

to use this gauge for the heater connections in order to avoid the possibility of voltage drop due to the comparatively heavy heater current taken by the valves.

Short stiff leads are soldered to the oscillator condenser prior to mounting it. The oscillator coils are supported by these wires. A little latitude for the

The 7,000 ohms anode load resistance of the output valve must be 3-watt rating, as any change in value of its resistance due to heating will adversely affect synchronism. If a 7,000-ohm 3-watt resistance is not readily obtainable three 20,000-ohm 1-watt connected in parallel will be quite suitable.

The total H.T. consumption of the vision receiver unit is 90 milliamps at 250 volts. The valve heaters require 4 volts at 11 amps.

It is important to note if an existing power pack is to be used, that one side of the heaters is connected to earth; consequently if the centre tap of the heater winding on the mains transformer is connected to earth, this connection must be removed, otherwise damage will be sustained by the winding.

It will be seen that the terminal strip carrying the output and synchronising terminals is mounted on the underside of the chassis, as is also the terminal block for the supply connections. If it is intended to use the receiver with existing apparatus the terminal strip can, within limits, be mounted in a more convenient position.

It can be mentioned here that the receiver is very suitable for use with the associated gear of the "Guaranteed Receiver," described in the October,

OCTOBER, 1937

November and December, 1936, issues, and no alteration is required to the design of these units to obtain excellent results.

Full constructional details of a time base and power supply unit for use with the receiver will be described in next month's issue. Several unusual features are incorporated in the time base, resulting in considerable economy and ease of adjustment. In the following articles of this series the cathode-ray tube and time base power supplies will be dealt with, and in the final article full operating instructions for the complete television receiver will be given.

If it is intended to construct these units, which have

been especially designed for use with the receiver, the terminal strip mentioned above should be mounted as shown.

As shown, with three R.F. stages, the receiver is suitable for use at distances up to 65 miles. For distances up to 35 miles two R.F. stages will suffice, and one R.F. stage for very local service. The alteration necessary will be shown. Although fewer stages could be accommodated on a smaller chassis, this is not considered advisable, as the saving effected would be trivial. It is suggested, therefore, that the chassis dimensions given should be adhered to, regardless of the number of R.F. stages employed.

LISTS OF COMPONENTS, VALUES AND MAKES IN VISION UNIT

RESISTANCES

R1 50,000-ohms (½ watt) (Erie)	R25 50,000-ohms (½ watt) (Erie)
R2 100 " " (Erie)	R26 1,000 " " (Erie)
R3 10,000-ohms pot. (Reliance)	R27 250 " " (Erie)
R4 1,000-ohms (½ watt) (Erie)	R28 50,000 " " (Erie)
R5 5,000-ohms " " (Erie)	R29 1,000 " " (Erie)
R6 50,000-ohms " " (Erie)	R30 250 " " (Erie)
R7 250 " " (Erie)	R31 1,000 " " (Erie)
R8 1,000 " " (Erie)	R32 5,000 " " (Erie)
R9 5,000 " " (Erie)	R33 5,000 " " (Erie)
R10 50,000 " " (Erie)	R34 100 " " (Erie)
R11 250 " " (Erie)	R35 7,000-ohms (3 watt) (Dubilier)
R12 1,000 " " (Erie)	R36 2 megohms (½ watt) (Erie)
R13 50,000 " " (Erie)	R37 100,000-ohms (½ watt) (Erie)
R14 100,000 " " (Erie)	R38 100,000-ohms Pot. (Reliance)
R15 50,000 " " (Erie)	R39 10,000-ohms (1 watt) (Dubilier)
R16 1,000 " " (Erie)	R40 200-ohms (½ watt) (Erie)
R17 250 " " (Erie)	R41 50,000-ohms (1 watt) (Dubilier)
R18 50,000 " " (Erie)	R42 5,000 " " (Dubilier)
R19 20,000 " " (Erie)	R43 5,000 " " (Dubilier)
R20 50,000 " " (Erie)	
R21 1,000 " " (Erie)	
R22 250 " " (Erie)	
R23 1,000 " " (Erie)	
R24 1,000 " " (Erie)	

CONDENSERS.

C1 25 mmfds. variable (Premier)
C2 .0003 mfd. type M (T.C.C.)
C3 0.01 mfd. type 691 (Dubilier)
C4 Trimmer 30 mmfds. max. SW95 (Bulgin).
C5 0.0003 mfd. type M (T.C.C.)
C6 0.0003 mfd. type M (T.C.C.)
C7 0.01 mfd. type 691 (Dubilier)
C8 Trimmer 30 mmfds. max. SW95 (Bulgin).
C9 0.0003 mfd. type M (T.C.C.)
C10 0.0003 mfd. type M (T.C.C.)
C11 0.01 mfd. type 691 (Dubilier)
C12 Trimmer 30 mmfds. max. SW95 (Bulgin).
C13 0.002 mfd. type 690W (Dubilier)
C14 0.0003 mfd. type M (T.C.C.)
C15 0.1 mfd. type 4603/S (Dubilier)
C16 Trimmer 30 mmfds. max. SW95 (Bulgin).
C17 0.01 mfd. type 691 (Dubilier)
C18 0.001 mfd. type 690W (Dubilier)
C19 25 mmfds. variable (Premier)
C20 0.1 mfd. type 4603/S (Dubilier)
C21 0.002 mfd. type 690W (Dubilier)
C22 0.0003 mfd. type M (T.C.C.)
C23 0.002 mfd. type 690W (Dubilier)

C24 Trimmer 30 mmfds. max SW95 (Bulgin).
C25 0.01 mfd. type 691 (Dubilier)
C26 0.0003 mfd. type M (T.C.C.)
C27 0.002 mfd. type 690W (Dubilier)
C28 0.002 mfd. type 690W (Dubilier)
C29 Trimmer 30 mmfds. max. SW95 (Bulgin)
C30 0.01 mfd. type 691 (Dubilier)
C31 0.002 mfd. type 690W (Dubilier)
C32 0.0003 mfd. type M (T.C.C.)
C33 0.002 mfd. type 690W (Dubilier)
C34 0.01 mfd. type 691 (Dubilier)
C35 0.0005 mfd. type 690W (Dubilier)
C36 Trimmer 30 mmfd. max. SW95 (Bulgin).
C37 0.00005 mfd. type 690W (Dubilier)
C38 500 mfd. type 501 (T.C.C.)
C39 .5 mfd. type 4608/S (Dubilier)
C40 0.1 mfd. 350 volts D.C. type 4603/S (Dubilier)
C41 0.1 mfd. 350 volts D.C. type 4603/S (Dubilier)
C42 0.0001 mfd. type 690W (Dubilier)
C43 0.0003 mfd. type 690W (Dubilier)
C44 0.0003 mfd. type 690W (Dubilier)
C45 0.0003 mfd. type 690W (Dubilier)

SUNDRIES.

H.F. Choke type 1010 (Eddystone).
8—Valve thimbles type P41 (Bulgin).
1—Screened valve cap type P65 (Bulgin).
7—7-pin chassis mounting valve holders (Belling-Lee).
2—5-pin chassis mounting valve holders (Belling-Lee).
2—7-pin valve holders type 1024 (Eddystone).
1—Terminal block type 1046 (Eddystone).
1—4-way connecting block (Bryce).
1—Group resistor board. Cat. No. C 31 (Bulgin).
1—5-way terminal strip (Belling-Lee).
Chassis, nuts and bolts, wire, systoflex, etc.
9—1½ in. by ½ in. paxolin coil formers (Wright & Weaire).
1—Extension spindle. Cat. No. 1008 (Eddystone).

VALVES.

V1, V2, V3, V5, V6, V7, Mazda AC/SP3.
V4, Osram X41.
V8, V10, Osram D42.
V9, Mullard TSP4.
V11, Marconi MSP4.

CHASSIS.

1—Aluminium to specification (Mervyn).
--

CATHODE RAY TUBE.

1—Type 10H or 7H (Ediswan).

"The Philips Projection Receiver"

(Continued from page 581)

Pen A4. The H.T. for the time bases and amplifiers is provided by two IW4 valves.

The main on/off switch for television and broadcast is operated by drawing forward the tilting dial which, in the off position, lies flush with the front of the cabinet. The wavechange and television switch is operated by the moulded ring which encircles the mono-knob on the front of the cabinet.

Controls

For television there are four main controls grouped into two concentric pairs located on a sunk panel

under the lid and in front of the screen. The right-hand pair only need occasional adjustment, as they control the tuning (large knob) and the focus on the cathode-ray tube. The tuning control combines both sound and vision, the correct tuning for vision being the point where the sound accompaniment has maximum volume for a given setting of the volume control.

The left-hand pair are: A large knob for background, which controls the amount of light on the screen by varying the bias on the cathode-ray tube, and a small knob for contrast, which varies the gain of the vision amplifier.

The pre-set controls are located to

the right of the main controls under a small hinged cover to prevent accidental mis-adjustment. The left-hand pair control time-base frequencies, the middle pair control size of picture on the screen, and the right-hand pair control centring of picture on the screen. In every case the small knob controls the vertical and the large knob the horizontal components of the picture.

Excellent pictures were obtainable with this instrument, and the picture being projected on to a flat screen is quite free from any distortion. The extra high sensitivity enables results to be obtained outside the normal service area, provided conditions of local interference permit.

THE SMALL-SCREEN RECEIVER

—A WELCOME INNOVATION

A great deal of interest was aroused at Radiolympia by the introduction of the small-screen and table-model television receivers. Despite the demand there has been for bigger pictures it is apparent that these types of receivers by enabling a considerable reduction in the price to be made will be very popular for home use.

ONE of the chief items of criticism of the television picture during the past twelve months has been regarding the size of the screen. On the face of this criticism it may seem rather surprising that a

transmission, and that increased picture size merely means that the picture will have to be viewed a greater distance away.

Home viewing and public demonstration are under entirely different conditions. In the former the audience will rarely exceed half a dozen people, whereas in the latter the number may, and probably will, be any number up to thirty or forty, which necessitates a good proportion of them being some considerable distance away from the screen. Actually, it has been calculated that the ideal size of screen with the present standard of definition is nine inches, with a viewing distance of six to eight feet; any increase of picture size means that the viewing distance will have to be increased if the picture is to be seen without its composition being very apparent.

For Home Use

It is evident, therefore, that there is a very good case for the small-screen receiver and providing that it is used under home conditions without a large audience it will provide adequate entertainment. If this type of receiver suffered at the Radiolympia demonstrations by comparison with the larger receivers it was merely because the majority of viewers were of necessity too far away. Under home conditions the small screen provides an excellent picture and the detail is such that it can be viewed at close quarters in comfort and as much detail seen as with the larger screen.

The fact that this reduction of screen size enabled several manufacturers to produce receivers at prices ranging from £35 to £45 created a great deal of interest, because it has brought television within the reach of the average person. At these prices the cost of a television receiver is very little in excess of a good class broadcast receiver and lower than many radiograms. Running costs are also low which may be assumed to be in the region of about

a penny per hour. Another feature is that the receivers of this type occupy very little space and most of them are described as table models, although special stands are available in most cases.

The Cossor

Cossors have produced a table model which, although small as far as the cabinet is concerned, gives a medium-sized picture as actually a 10-in cathode-ray tube is employed. It is designed for receiving television and its accompanying sound only. The picture, though slightly smaller than that rendered by the Console models, is of ample size for home entertainment and the reproduction is very fine indeed. The price is 45 guineas.

Ekco

The Ekco table model is priced at 45 guineas, and it provides a picture as bright and with as good definition as the larger instruments. The cabinet measures only 27 in. by 19 in. by 20 in. There are only two main controls and the receiver provides television sound and vision. As the viewing angle is wide (120

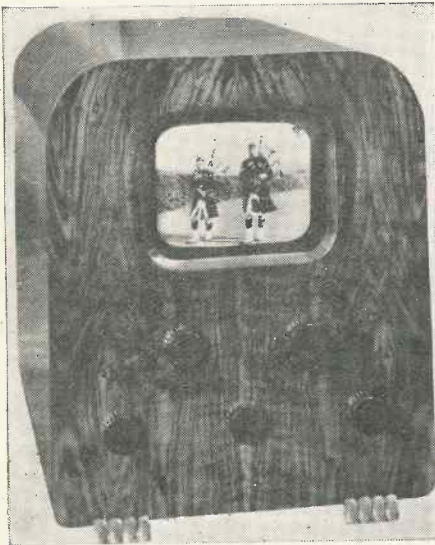

The G.E.C. table-model receiver incorporates a convertor which allows of it being used in conjunction with an ordinary broadcast set for reception of television sound. It sells at the very low price of £35.

number of makers have introduced receivers this year with screens that are even smaller than those which we have regarded in the past as a suitable minimum. Of course, the true reason for this is to enable a reduction to be made in the price and without this advantage, which the small screen makes possible, it may be assumed that the tendency would be for an increased screen size.

There is, however, much to be said for the small screen. In the past criticism of screen size has come from the general public who, for the most part, have only made the acquaintance of television in public viewing rooms, and more often than not under conditions of viewing distance which exaggerated the deficiencies which may have appeared apparent. There is also the point that the average person does not realise that the definition is limited by the standard of



The Cossor table-model receiver includes television sound and is therefore complete in itself. A 10 in. tube is employed and picture size is ample for home use. The price is 45 guineas.

degrees) half a dozen people can watch in comfort and be sufficiently near the screen to see every detail.

BAIRD TELEVISION LTD.

**WORLD PIONEERS & MANUFACTURERS OF
ALL TYPES OF TELEVISION EQUIPMENT**

**★ FIRST IN 1926 ★
★ FINEST IN 1937 ★**

Brilliant pictures, freedom from distortion, excellent detail, wide angle of vision, extremely simple operation, high fidelity sound and all-wave radio are among the factors contributing to the first-class performance of all Baird Television receivers. Incorporating all the latest features in television development, every model in the range represents the high-water-mark of achievement.

★ ★ ★ ★

Each television receiver incorporates a Baird "Cathovisor" Cathode Ray Tube which has the outstanding advantage of being completely electro-magnetic in operation. These tubes can be supplied separately with the necessary scanning equipment where desired. Apart from manufacturing processes, stringent tests are made for electrical emission, tube characteristics, filament rating, and screen quality, and following normal picture reconstitution under service conditions, every Baird Cathode Ray Tube, on completion, is subjected to a very high external pressure test. Baird "Cathovisor" Cathode Ray



One of the New Baird Receivers
Model T.11

Tubes are the ideal solution for high quality television pictures.

★ ★ ★ ★

A large number of Flat installations have already been undertaken by the company, and amplifier equipment for this purpose is now available. Vision and sound are provided "on tap" in any room desired, and technical advice will be given by the company's experts on all points.

★ ★ ★ ★

Another new development is the Baird Multiplier Photo-electric Cell, of which there are two main types, suitable for either a concentrated light beam or diffused light. The Baird Multiplier is a chain of electron permeable grid stages, and under service conditions current gain factors of the order of 100,000 can be obtained. Cathode sensitivity is approximately 30 micro-amps per lumen. These Multiplier Cells are suitable for all television and sound on film work, together with many industrial applications where high gain, coupled with sensitivity and extremely high signal to noise ratio, is essential.

Write for latest literature
describing :

**BAIRD RECEIVERS MODELS T5C,
T.11, T.12 and T.13.
MULTIPLIER PHOTOCELLS.
12 in. 15 in.
"CATHOVISOR" C. R. TUBES.
"CATHOVISOR" C. R. TUBE
SCANNING EQUIPMENT.**

Post free on request.

Head Office :

Laboratories :

**Greener House, 66, Haymarket,
LONDON, S.W.1**

**Crystal Palace, Anerley Road,
LONDON, S.E. 19.**

'Phone: Whitehall 5454

'Phone : Sydenham 6030

G.E.C. Simplification

The G.E.C. have been able to bring the price down to a very low figure in their table model receiver by an ingenious combination of the vision receiver with an ordinary broadcast receiver. The G.E.C.

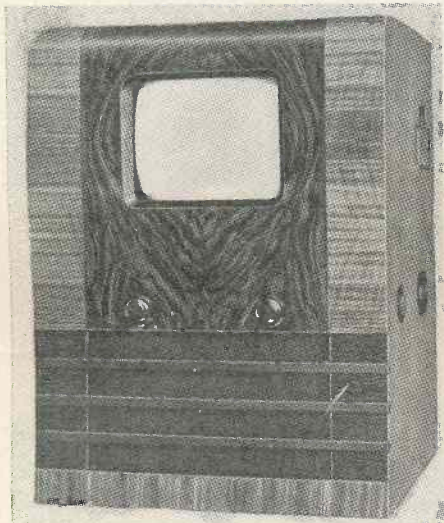

The Ekco miniature also provides television sound and vision and the results are excellent. Priced at 45 guineas it represents very good value.

vision unit connects up to the ordinary radio set without any modification and while it gives on its 6 in. by 4½ in. screen a picture of exceptional clarity the accompanying sound is reproduced on the radio

receiver. This instrument, the first of its kind in the world, has been evolved by the G.E.C. television engineers and was demonstrated at Radiolympia. Already it is in course of production and will be available to the public in a month or two. Priced in the neighbourhood of £35, it will bring television within the means of tens of thousands of listeners within 30 miles radius of Alexandra Palace and from other stations when they are established.

Pye

In the Pye Teleceiver range there is a Minor model which provides a picture 7½ in. by 6 in. Priced at 43 guineas, this is a Console model and except for its size follows upon ordinary lines. The instrument has only two principal controls and the price includes aerial and installation. Magnetic scanning is used in the Pye receiver.

Ultra

The Ultra small-screen receiver provides a picture 7¼ in. by 6¼ in., and the price is 38 guineas. This is not a table model but the cabinet is quite small, the actual measurements being 36 in. high, 21 in. wide and 20 in. deep. This receiver incorporates television sound and vision. Magnetic deflection is used and an economy in valves is effected by using Thyatron time base generators for separating the syn-

chronising impulses, a total of fifteen valves being employed.

Receivers of the foregoing types should do much to popularise television, not only by reason of the reduction of the first cost, but also because of their simplicity and low running and maintenance costs. The ordinary television receiver has

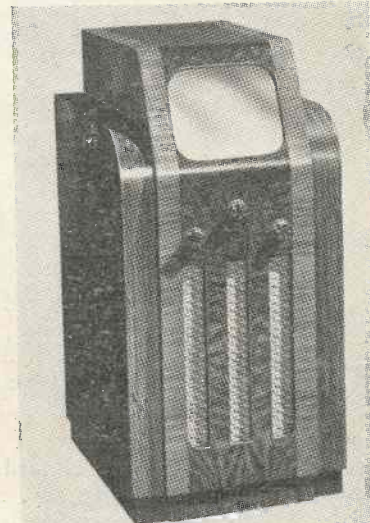

The Pye Minor model is a console with a directly viewed picture. Except for picture size it is built upon conventional lines.

proved very reliable and there is no doubt but that the same will be the case with the Junior type of receiver and in the event of replacements being necessary the cost will be trifling.

Book Review

Radio Engineering (2nd Edition).
F. E. Terman. McGraw-Hill
Publishing Co. 30s. net. 796
pp., 474 Figs. in text.

Contents: Elementary Principles of Radio Communication; Circuit Constants; Resonant Circuits; Vacuum Tube Amplifiers; Power Amplifiers; Oscillators; Modulation; Detection Power Supplies; Transmitters and Receivers; Propagation of Waves; Antennas; Navigation Aids; Television.

This is the second edition of Prof. Terman's book which was originally published in 1932. The author states that it has been completely revised in view of the rapid developments which have taken place in radio theory and practice since that date, and it may thus be considered as a new book.

The amount of extra material which has been included in this edition is such as to make it the most comprehensive text-book of its kind and the most up-to-date.

After the usual introductory matter on the theory of radiation and the properties of vacuum tubes (including the beam power tube) we have over 100 pages devoted to the subject of vacuum tube amplifiers. The various classes of amplifiers are described in detail and there are several curves giving the relative performance of amplifiers with varying component values. A section is devoted to negative feed-back. Under power amplifiers a complete worked example is given of Class C amplifier performance, and at the end of each chapter several examples are given having a bearing on the problems discussed.

The chapter on power supply for amplifiers is perhaps one of the most valuable contributions to the subject which has yet appeared. Many experimenters have felt the need for a concise description of the relative merits of the various filter circuits and their effect on the output and efficiency of supply units, and the

literature on the subject is not easily found. A chart on p. 493 gives the relation between the per cent. ripple, peak current, and D.C. voltage for various values of load resistance and although calculated for 60 cycles is of great use to the British radio experimenter.

The chapter on television is a very brief survey of the general principles, but if read in conjunction with the previous matter the reader would have no difficulty in understanding the special requirements of video amplifiers.

The book is remarkably free from errors and has a comprehensive bibliography, the main references being to the I.R.E. Proceedings. This seems to be usual in American text-books.

Whether for American or British readers, Prof. Terman's book is excellent and cannot be too highly recommended. All radio students and experimenters should possess a copy.

THE TELEVISION OF FILMS

This article gives the first published details of the method employed in televising films. In view of the present series of film transmissions from the Alexandra Palace it is of particular interest.

HERE has recently been commenced a series of film transmissions intended primarily for the benefit of radio manufacturers and dealers in order to enable them to make tests and give demonstrations. Details of the manner by which films are transmitted have not been published hitherto and it is the purpose of this article to describe the method employed.

The film used is the standard 35 mm. type complete with sound track. Standard film is prepared to run at 24 frames, that is to say, 24 separate pictures per second, which is a linear footage of 89 per minute. To project standard film two main types of projectors are used termed "intermittent" and "continuous" and, as their names imply, in the former the film passes through the machine in a series of rapid intermittent movements and in the latter with a smooth continuous motion. It is the intermittent type which is used in cinemas, the continuous type never having found

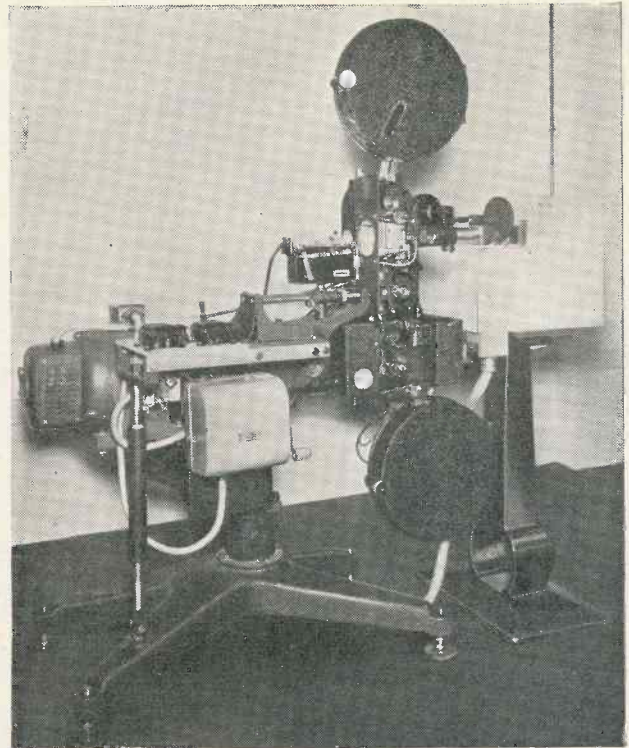

The film projector and scanning camera for televising film pictures.

favour in this country or America, though this type is employed on the Continent.

In the intermittent type of projector the film passes from the top spool box to a continuous feed sprocket A (Fig. 1), into the "gate," through which it is drawn by a series of jerks, coming to rest between each downward movement, due to the intermittent motion of the sprocket X, the continuous take-up sprocket B finally passing the film into the bottom spool box via the sound head. This intermittent movement of the film through the "gate" is arranged so that the film is at rest for a considerably longer time than it is in motion. Owing to the fragility of celluloid and the strain of sudden movement, a ratio of one of motion to three of rest is the optimum.

Next we must consider the shutters which cut off the movement of the film on the screen. A segment inserted in the ratio of one to three as in the black area, Fig. 2A, will give a clear picture, but with a pronounced flicker of 24 per second, which is very noticeable, so an additional segment is inserted as in Fig. 2B, which brings the flicker speed up to 48, which is above the normal power of the eye to resolve. The effect of the shutter is shown diagrammatically in Fig. 3A in the form of a picture on and off the screen for two frames.

Such is a normal projector and we must now see how it fits in with television standards. The great difference is, of course, the frame speed, television being 25 as against 24. This is no serious problem, as increasing projection speed by one frame per second is simply a matter of gearing and the increase in the movement is unnoticeable except to the most expert eye; also the raising in pitch of the sound is not generally noticeable, so the normal film projector is run at 25 frames per second for television purposes.

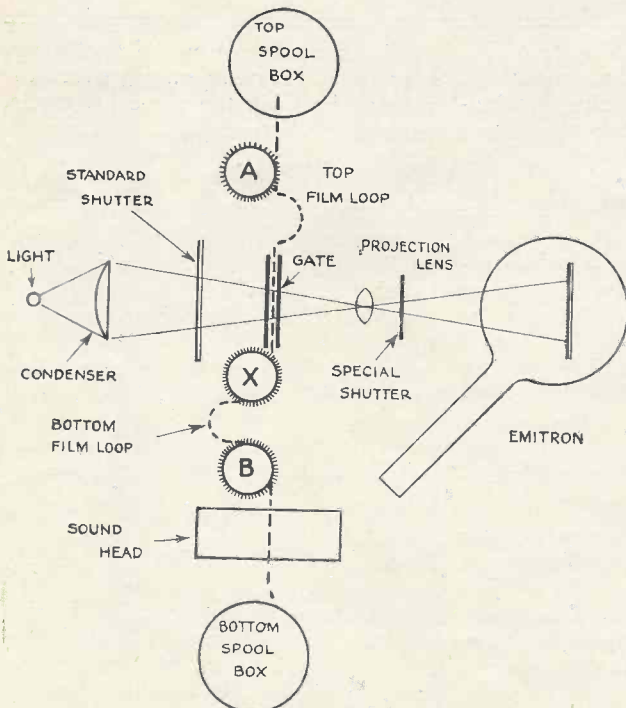

Fig. 1.—Schematic diagram showing the method employed in film transmission.

FLICKER IN FILM TRANSMISSION

Though television is transmitted at 25 frames per second the scanning is interlaced, which means that it is necessary to scan the same scene twice; also while in the case of the film it is only being projected for half of the frame time, in television for the equivalent pro-

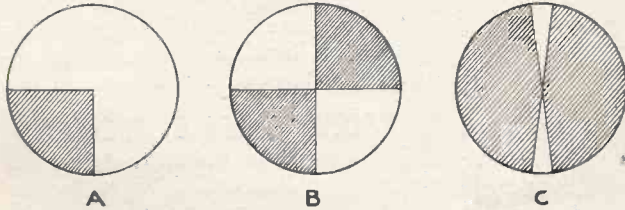

Fig. 2. Effect of shutter speed upon flicker.

jection the actual scanning goes on for approximately nineteen-twentieths of the frame periods. The signal of two television frame periods is shown diagrammatically at B, Fig. 3.

The first thing in transmitting a television picture is to project a light image of the scene to be televised on to the photo-electric mozaic of the Emitron. For a start let us project the film from our standard projector, not on to a normal screen, but on to the mozaic plate. The image of the film will, of course, not have to be magnified more than some six diameters, instead of the more usual hundreds for a normal screen. Turning again to our diagram of Fig. 3A and B, let us start the cycle of operations and try and draw a picture of their resultant at C, Fig. 3.

As no picture has been projected on to the mozaic for the first quarter of the frame time, no signal will result; at the commencement of the second quarter, a picture is projected on the mozaic which results in a signal of rising intensity, the increase in intensity being due to the cumulative storage effect of the mozaic. This signal would cease at the synchronising signal.

Avoiding Flicker

At the commencement of the second scan the flicker shutter will be in operation so that no more light would fall on the mozaic, but a signal would result from the storage effect during the exposure of the previous quarter. During the last quarter a rising signal will again be produced (which one might expect to represent as in the diagram), but it may have suffered somewhat from the second quarter's scanning, it being somewhat doubtful as to the effect of scanning the odd lines on the adjacent even ones and vice versa.

Commencing the second frame, again on the first quarter no picture falls on the mozaic as the shift segment of the shutter is closed, but a signal will result owing to the storage effect, while on the second quarter an existing storage charge is added to as the picture is again projected on to the mozaic and another rising-intensity signal will be produced, and so on with steady and rising signal every other quarter of the frame period.

The result of all this would be a quite impossible picture. It would appear to flicker badly with hori-

zontal black line travelling up or down it. To overcome all this another mechanical shutter is introduced, so arranged as to project a picture on the mozaic only when the mozaic itself is not being scanned, that is to say during the period of frame synchronising and black level signal, the actual shutter running at frame speed with two opposite sectors of about 14 degrees (see Fig. 2C) and so phased with the normal shutter as to open in the middle of its open position, the synchronising pulse being also so placed. As the shutters driving sound and synchronising signal are controlled from common A.C. mains, once set up there is no difficulty in keeping all three in proper relationship.

There has been a certain amount of criticism regarding film transmissions, and it is the opinion in many quarters that the films transmitted by the Baird system with 240 lines were superior to those at present being radiated (apart from flicker); also that the results given by the Cossor film transmitter at the Science Museum are superior to those radiated from Alexandra Palace.

Film transmissions certainly are not technically so good as the direct material from the studio and it is

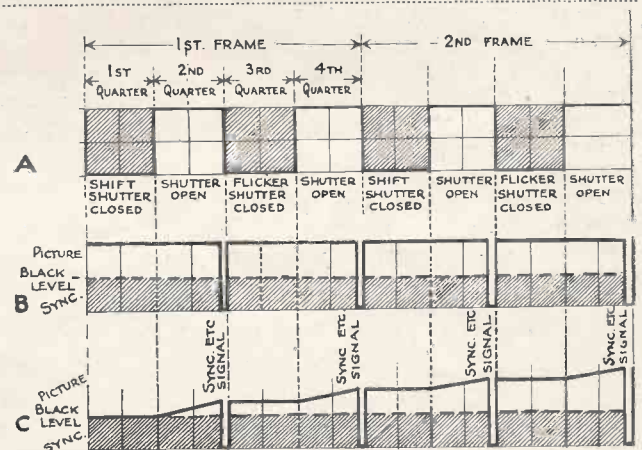

Fig. 3. Diagram of cycles of operation transmitting film.

evident that the present photo-electric mozaics which suffer from electronic leakage and secondary effects will have to be improved or another method found for using them. It would appear that the continuous film projector of the revolving mirror type would be eminently suitable to make the best use of the present photo-electric mozaic.

Coils and Chassis for the Low-cost Televisor

Constructors who do not wish to make their own coils and chassis for the Low-cost Televisor will be interested to know that both these can be obtained from the Mervyn Sound and Vision Co., Ltd., of 4 Holborn Place, London, W.C.2. The coils, which are wound to specification, are supplied ready for mounting and the chassis completely drilled and ready for assembly, which is a simple matter by means of 6 B.A. screws and nuts, which are included with the metal work. (The price of the receiver chassis is 45s.)

Scannings and Reflections

FOOTBALL TELEVISION

THE experiment at the Arsenal football ground gave viewers an idea of the work which goes on behind the scenes of a first-class football club. (The pictures, which included demonstrations of ball-trapping by Bastin and head-work by Drake, Roberts, Hapgood, Male and others, were picked up by the Emitron cameras located at vantage points around the ground, and were transmitted by the mobile television unit direct to the Alexandra Palace. One half of the team watched by television the other members undertaking their training.

This is the first time that a television broadcast has been made from a football ground, and it was an experiment to test the practicability of including football matches in the television programmes. Three cameras were used: one on the stands to give a comprehensive view of the ground, and two others near the goal mouth.

"CARNIVAL"

Members of the Vic-Wells Ballet Company will visit Alexandra Palace on October 11 for an afternoon and evening performance of Schumann's "Carnival," arranged as a ballet by Michael Fokine, with orchestration by Gordon Jacob. It is hoped that all the leading members of the famous Vic-Wells Company will be present, including Elizabeth Miller, Ursula Moreton, Mary Honer, Joy Newton, Harold Turner, Frederick Ashton, William Chappell, Claude Newman and Robert Helpman.

PINEWOOD FILM STUDIOS

The mobile television unit will be stationed at the Pinewood Film Studios, Iver Heath, Buckinghamshire, from September 30 to October 5, to give direct shots of films in the making. Jessie Matthews, Maurice Chevalier, Adèle Astaire, and other stars of the screen will be seen during actual filming, so that viewers will obtain a first-hand impression of how a big picture is built up. Transmission from the film

stages will be given on three nights. The first will show Sonnie Hale directing the new Gaumont-British picture, "Sailing Along," with Jessie Matthews, Jack Whiting, Roland Young, and Barrie McKay. On another evening Monsieur René Clair, the distinguished French director, will be seen at work on a new Jack Buchanan picture with Maurice Chevalier, and Adèle Astaire on the set. The third stage shot will show a British Paramount film in production.

During the afternoon transmissions from Pinewood, which will be given daily, viewers will be taken behind the scenes to see the workshops, the power house, the plasterers' shop, and the boardroom of the Pinewood Studios. This is actually the rebuilt saloon of the *Mauretania*. The cutting rooms will also be visited, as well as the twenty-two-acre garden which has figured in many of the films which have come from the Pinewood Studios since they were opened twelve months ago. During the television inspection of the models department it is hoped to stage a train smash. The tour will include the dressing rooms, and it is hoped that such stars as Nova Pilbeam, Will Hay, Lili Palmer, and the boy actor, Desmond Tester, may act as guides. Mr. Alfred Hitchcock, the eminent director, may also face the television camera.

NEW TECHNIQUE

The programme transmitted on September 28, when viewers were given a complete story of the arrival and departure of a great liner at Southampton, was by a combination of studio performance and specially prepared film. A television producer and photographers made a film record at Southampton. The vessel was first "picked up" as it neared Calshot; shots were taken from the captain's bridge and later of the passengers landing, the unloading of the luggage and cargo, and the complicated manoeuvre of turning round in dock until the liner once more had her nose towards Quebec. This is

the first time that a film unit has gone "on location" to secure material for a television programme.

TELEVISION SALES TREBLED

The impetus given to television during the Radio Exhibition by the public demonstrations and by the substantial drop in set prices is already reflected in increased sales. In the first week after the show ended, the G.E.C. received more inquiries than in the previous three months, while orders received for television sets in the past two weeks were three times greater than during any similar period since the television service began.

TELEVISION TRAILERS

High lights of the next week's television programmes are soon to be radiated as a regular Friday feature. In many cases the artists will appear in person in excerpts from forthcoming drama, variety, ballet and other productions. Sometimes film may be included.

The trailers will be presented with all the care that would be expended on the final production and will be handled by the television announcers. (The first trailer may be expected early this month.)

TELEVISION AND THE DEAF

Following a suggestion that television appeared to offer great possibilities to those people who were deaf and to whom radio has meant nothing, the General Electric Company has been interesting itself in the matter. As a result a G.E.C. television set was installed at Tower House Home for Deaf and Dumb Men. Recently it was decided to carry the experiment a stage further.

There are in the home a number of men who are not completely stone deaf, and they have been in the habit of listening to the radio by special amplifying headphones. Some of them, however, are unable to distinguish sounds—some of them, for example, cannot tell the difference between music and talks—and so the radio was providing very little enter-

OCTOBER, 1937

MORE SCANNINGS

tainment. To be able to see at the same time, however, provides an interpretation of the sound.

It has been found in actual fact that the co-ordination of the aural and visual faculties does assist the men to hear, or to understand what they are hearing. Among the patients is an ex-soldier who was deafened in the war, and he has heard for the first time since the G.E.C. attached their special headphones to the television set. It seems likely that headphone television will be a valuable adjunct for teaching deaf children.

Only a small proportion of the men are affected by the sound, and television still continues to give pleasure to those who are totally deaf. According to Mr. D. A. C. Ellwood, superintendent of the Home, the men have been exceedingly enthusiastic about television.

The headphones are attached to the output of the receiver by means of a special matching transformer, which provides means of varying the sound characteristic to suit the traces of aural response shown by the patients. The receiver itself is a 23-valve superhet model with a direct vision television picture. The experiment appeared to offer such chances of success that the television set was presented to the Home by the G.E.C.

The promise of success was indicated in many interesting ways. For instance, some of the deaf men with earphones beat time to the music. At least two men added ten words to their vocabulary. One man watching a girl singing suddenly looked inquiringly at the Superintendent indicating that he no longer understood the words. Actually the girl had just begun to sing in German. When five claimed that they could hear the sounds, the sound was switched off. Three knew at once, and a fourth after a few moments.

THE TELEVISION DEMONSTRATIONS

As a result of the great public interest in television at Radiolympia, many people were unable to find room in the demonstration theatres, and even though three extra television transmissions were given on the last day of the Exhibition thousands of people were disappointed.

These extra transmissions were

only possible with the limited studio accommodation available at Alexandra Palace because the repetition of special programmes for Radiolympia did not involve the rehearsals which are held between the afternoon and evening transmissions, when the normal programme service is working.

COMMERE FOR TELEVISION

The first *commère* in television is Miss Sheila Douglas-Pennant, who introduced artists in Harry Pringle's cabaret on September 27 and October 1 in the evening and afternoon programmes respectively. Miss Douglas-Pennant, who is nineteen years old, has already acted as *commère* in West End cabaret shows. She sings and dances and is an adept at "patter"—an essential qualification for this work.

TELEVISIONING THE NORTH LONDON EXHIBITION

One of the first outside broadcasts by high-definition television nearly a year ago will be repeated when the cameras range the North London Exhibition in Alexandra Palace on Wednesday, October 13. The feature will be included in the afternoon and evening editions of Picture Page, the television topical magazine.

The North London Exhibition brings housewives and many of their men folk from all over London to see the latest household utensils and

labour-saving devices. Television cameras will visit the cabaret show with glimpses of the Dress Parade.

A WEAK LINK

The introduction of the mobile television vans appeared to herald a new line of development. It was originally thought that these vans would be able to send by radio link to Alexandra Palace anything within the scope of the Emitron camera, for these vans can be operated up to 15 or 20 miles from the transmitter when conditions are good. It is unfortunately this qualification that is the weak link. Although the transmission from Wimbledon was highly satisfactory, the same cannot be said of the proposed transmissions from Hatfield of the Round-England Air Race.

At the Alexandra Palace during one of the periods when these transmissions from Hatfield should have been taking place, although the field strength provided by the mobile transmitter was more than adequate, interference on the same frequency made it impossible for the start of the race to be televised.

What is even more worrying is that during the ensuing three days neither the B.B.C. nor the Post Office with their special detector vans could do more than localise the source of the interference. It was not actually traced to its source, so for that reason the transmissions had to be washed out.



An experiment unique in the history of television and of football was made at the Arsenal ground recently when one half of the team watched by Television the other members undertaking their routine training. From Mobile Television Unit in the Stadium, the pictures were transmitted to the Alexandra Palace, and from there were re-radiated on the normal television wavelength and picked up on a Marconiophone television receiver in the Directors' Room in the East Stand.

As interference on ultra-short waves is rather widespread at the moment and will probably remain so until a Bill is introduced to legalise its suppression by the Post Office, we can anticipate more failures, not due to lack of field strength, but to interference on the transmissions. It must also be remembered that motor car ignition can be particularly troublesome on 5 metres, the wavelength approximately used by these vans, so it will be interesting to see how the B.B.C. propose to overcome this difficulty.

It might be advisable to use a considerably lower wavelength, but this, of course, would only be a satisfactory proposition over comparatively short ranges.

TELEPHONE SERVICE TO TRAWLERS

Any telephone subscriber can now talk to any of the British trawlers which are within 100 miles or so of a Post Office coast wireless station. Most trawlers off the east and west coast are equipped for wireless telephony and keep in contact with Humber radio, near Grimsby, and Seaforth radio, near Liverpool. Subscribers wishing to talk to a trawler merely find out whether the boat is on the east or west coast, and then merely ask for Humber ship telephone service, or Seaforth ship telephone service.

TELEVISION RECEIVER SALES

Price reductions have indicated that the general public are well prepared to buy a television receiver at a reasonable price, despite poor programmes being transmitted. Even though television receivers are still a little more expensive than the average radiogramophone, modern easy hire-purchase terms make this rather unimportant, so for that reason some of the television receiver manufacturers have been able to register greatly increased sales since the last price reduction. The comparatively limited picture size also causes very little comment, and in most instances appears to be adequate for use in the average private house.

A NEW 5-METRE RECORD

Following quickly on the record set up by the British amateur, G5BY, when he received a report from America, come details of a further record from Australia. The well-known amateur, Don B. Knock,

VK2NO, the Radio Editor of the *Sydney Bulletin*, has received a report from the British amateur, Cecil Mallanby, of Pwllheli, North Wales, informing him that his 5-metre transmissions were received when he was in contact with another 5-metre Australian station, VK2HL. The signal report was Q2-4, R2-4 with heavy noise-level, but even so, this is the first Australia-England report.

Cecil Mallanby has also received a number of American stations on 5 metres, and in view of the details given, VK2NO places every reliability on this report.

ANOTHER AMERICAN SHORT-WAVE CHANNEL

As most 1937 all-wave receivers tune down to 13 metres, listeners are finding that the 13-metre commercial channel is one of the most productive for daylight American reception. Both the N.B.C. and Columbia short-wave stations, which operate on 13 metres, can be heard after mid-day at signal strengths equal to that obtained from some of the more powerful continental broadcast stations. At this time of the day, which greatly favours American very short-wave reception, programmes can be received without any background noise level and completely free from fading. In time to come, when all-wave sets generally tune to 7 metres, the 9-metre commercial channel will probably come into its own.

SHORT WAVES FROM TOKYO

In view of the international interest aroused by the trouble in Tokyo, short-wave listeners are endeavouring to locate the Tokyo station which is transmitting special news bulletins. It so happens that the new Tokyo station which operates in the 19-metre commercial channel has an aerial beamed on Europe, so for that reason signals can be picked up with the greatest of ease and with almost unbelievable volume.

Even listeners who have not had any experience of all-wave listening have commented on the ease with which they can hear Tokyo. This idea of broadcasting views on current affairs seems to be growing, for nowadays any international dispute automatically means that the nearest short-wave station is pressed into service so that the world will know at least one angle of the dispute.

BRITISH MANUFACTURERS AND THE SHORT-WAVE AMATEUR

At long last British manufacturers are beginning to realise that the average constructor, both of receiving sets and transmitting equipment, can utilise the equipment originally designed for commercial makers. Consequently, slowly but surely, British amateurs are finding a more or less complete range of components and valves of a type that has long been required. Foremost in developing this new idea of things are the valve-makers, who are now generally producing valves that normally have to be procured from abroad.

To a lesser extent, certain set makers are seeing that a good all-wave receiver, similar to those which amateurs do buy in large quantities from America, is assured of a ready sale, not only in this country, but amongst our colonies. Fortunately for us, our colonial buyers are still keen to obtain British-built equipment, despite the fact that the service is poor and the price usually higher than that asked by the American competitors.

TELEVISION FROM PARIS

Owners of television receivers on the south coast should make every endeavour to pick up some of the programmes which are being transmitted from the Eiffel Tower. This station has an estimated radius of 75 miles, but in view of the fact that it is already exceeding this range with only half its normal power, French technicians are of the opinion that vision may be picked up at 200 miles or so. Already faint signals have been received at Alexandra Palace from the Eiffel Tower so it will be interesting to see just what happens when the power is increased to 30 kilowatts.

W.B. Planoflex Loudspeakers

Constructors interested in obtaining high fidelity reproduction at minimum cost should obtain some information from Whiteley Electrical Co., Ltd., of their Planoflex loudspeaker. In our issue dated September, 1937, on page 555, there was a misprint in which we spoke about using a Planoflex in "Quaily Special" sets. This misprint would not, of course, deceive constructors, who, of course, know that the Planoflex loudspeaker is one of the best of its kind for normal home high-quality use.

OCTOBER, 1937

EXPERIMENTAL MINIATURE TELEVISION

A further article describing the experiments on the construction of a miniature television viewer using the R.C.A. 1-inch cathode-ray tube.

MANY visitors to the TELEVISION AND SHORT-WAVE WORLD's stand at Radiolympia no doubt noticed the power unit and tube chassis of the miniature equipment. The size was chosen with a view to its eventual inclusion in a small table cabinet, but experimenters who wish to make up the units to gain experience may use the "breadboard" type of layout without fear of interference or stray capacities.

The temporary showing of the chassis at Olympia has hampered the experimental work slightly and this month it is only possible to give the constructional details for the chassis, leaving the final component values to be chosen later. These will not, of course, affect the constructional work at all and in general will only mean the alteration of one of the

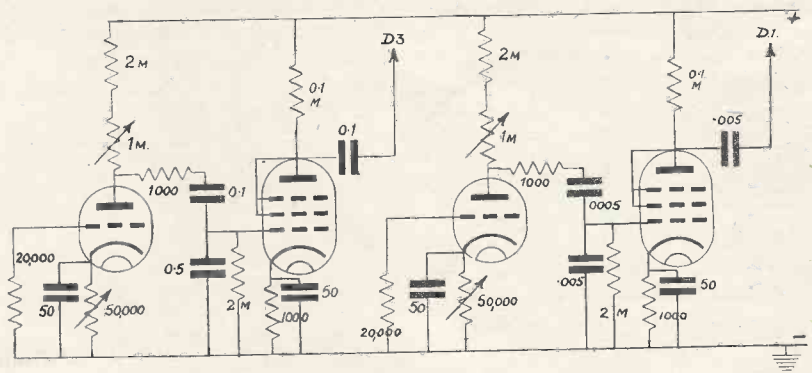

Fig. 1.—Diagram of simplified time base now being tested.

fixed resistances or condensers. With a view to simplifying the circuit, the author's* alternative diagram was tried. This is shown in Fig. 1 and will be seen to be of the conventional Thyatron type with a triode amplifier.

Push-pull amplification is useless with the tube used, as one of the deflector plates is permanently connected to the final anode inside the tube. This will also mean that perfect symmetry of the line screen will be impossible, and it may well be that this will spoil the efficiency of the unit

as a television reproducer. The condenser in both the line and picture circuits is charged through a resistance of 3 megohms and discharged through the Thyatron as shown. The output is divided so that a portion only is applied to the grid of the amplifying valve. The output of this valve again is taken to the deflector plates through the isolating condensers shown. The amplitude of the sweep is controlled by the bias of the Thyatron grid, a variable resistance of 50,000 ohms being connected in each cathode circuit.

In the original circuit two type 57 pentodes were specified, the various grids being connected together to serve as an anode.

The valve used was the 6K7, which was tried originally in the first circuit, but the 6J7 would be a closer equivalent.

No data was available on the use of these valves as triodes, but a rough estimate showed that they would probably be satisfactory. The deflection sensitivity of the tube at 350 volts is approximately 0.1 mm. per volt, giving 200 volts required for a sweep of 20 mm.

For reasonable linearity the striking voltage of the Thyatron should not exceed 40 volts and if one-sixth of this is applied to the grid for full swing the amplification of the valve is approximately 35.

Chassis Construction

The chassis is constructed from 1/16th in. aluminium sheet, bent into a hollow box with flaps on each side to a depth of 2 in.

At the ends of the box the flaps are

* The design of this receiver was originally published in America by A. O'Halloran.

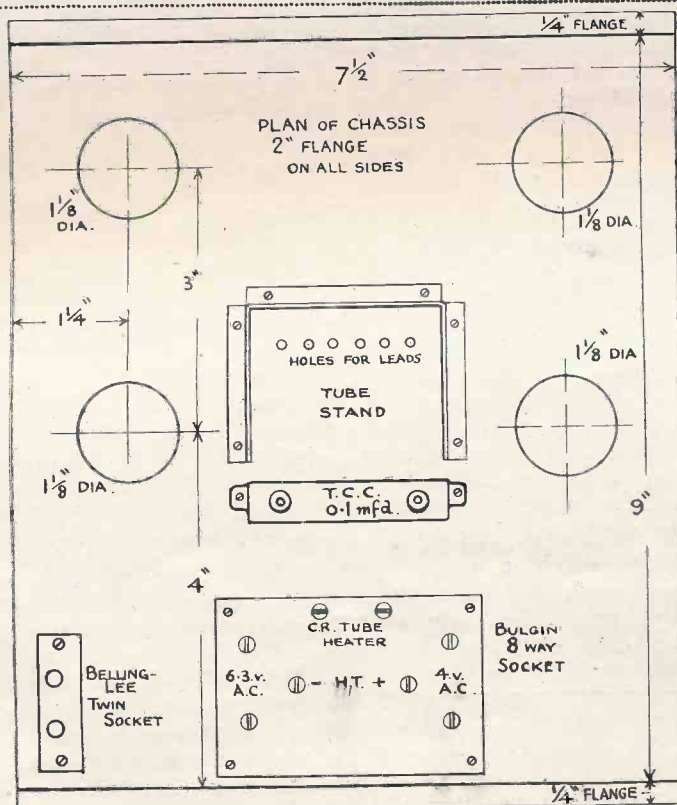

Fig. 2.—Chassis lay-out.

extended by a further $\frac{1}{4}$ in. which is bent out to act as a holding-down flange. The drawing of Fig. 2 shows the layout of the chassis. The tube itself and its controls is held on a separate bracket which is riveted on the top of the chassis in the position shown. The tube should project by about $\frac{1}{4}$ in. in front of the edge of the chassis when it is in place. Before bending up the bracket, cut the circular hole for the tube socket (a chassis type octal) and the $\frac{3}{8}$ in. clearing holes for the potentiometers. The tube socket is held to the metal by two 4 B.A. screws and nuts which pass through two slotted holes. These are to allow of rotation of the tube slightly to centre the trace on the screen. It is important to note the position of a tube when fitted in place. The mounting should be such that a line passing through pins Nos. 3 and 7 is in the horizontal plane, and the position of the slots is such that this is the case.

After the bracket (Fig. 3) has been prepared for mounting, the holes for the two valve sockets on each side of the tube can be cut, together with the clearance slot for the Bulgin 8-way socket.

This last is not essential but makes for a neat job and simplifies the wiring. Alternatively a row of eight terminals can be fitted on the chassis at the back. The synchronising sockets are fitted at the right-hand back corner of the chassis looking from the front. Finally, the holes for the four potentiometers are drilled in the front flap, $1\frac{7}{8}$ in. apart. These holes need careful checking as the clearance between the Dubilier potentiometers is slight. The potentiometers themselves will also need the soldering lugs bent forward to avoid touching one another and the potentiometer must be turned so that they are clear of the chassis.

The variable resistances are inserted in the following order: Left-hand side, 1 meg. variable for horizontal speed control, then 50,000-ohm amplitude control. Another 50,000-ohm for vertical amplitude control, and finally another 1.0 meg. on the right-hand side.

The final fitting is a Bulgin multi-resistance group board on the underside of the chassis immediately in front of the tube bracket. The edge of the group board should be $1\frac{1}{2}$ in. from the front flap.

Wiring

The potentiometer chain for the tube was shown in last month's issue

(Fig. 2, p. 524) and the potentiometers for control are fitted one below the other on the bracket. The fixed resistances can be mounted in the wiring vertically down one side of the bracket. The two condensers shown dotted are the Bulgin tubular type and are also hung in the wiring. In

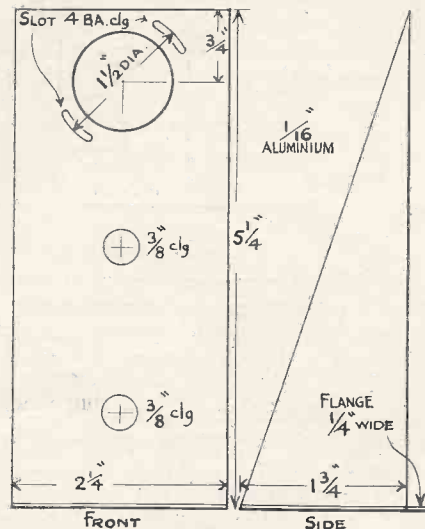

Fig. 3.—Details of tube supporting bracket.

making the connections it should be remembered that the anode is live and *not connected to chassis*. The resistances should be fairly rigid or they will touch the chassis when disturbed. Between No. 5 pin (the grid) and the slider of the potentiometer a 2-meg. $\frac{1}{2}$ -watt resistance must be connected for the modulating input. Finally, when the wiring of the H.T. chain is complete, a T.O.C. 0.1 mfd. condenser is fastened on the chassis immediately behind the tube bracket.

One terminal of this condenser is connected direct to pin No. 5 and the other is left free for the input connection to the tube from the radio receiver.

Dealing with the underside of the chassis, it will be found convenient to pack the tubular electrolytic condensers along the edge of the box. The connections of the eight-way socket are indicated, but these are not meant to be binding.

The resistances for the charging circuit and for the anode of the valves are held in the group-board. Al-

though 3 megohms variable is specified by the author it is a better plan to make 2 megohms out of the three fixed and leave the control to a variable 1-meg.. Experience with other time base circuits has shown that the less the value of variable resistance the better, apart from the finer degree of control provided. The value of fixed resistance will need adjustment after the set has been tried out.

Value of Components

For the H.T. exciter chain:

- 1—50,000-ohm 1-watt (Bulgin).
- 1—10,000-ohm 1-watt (Bulgin).
- 1—50,000-ohm variable (Dubilier).
- 1—10,000-ohm variable (Dubilier).
- 2—0.1-mfd. tubular condensers (Bulgin 500 V).
- 1 octal socket, type V₄ (Clix).
- 1 moulded case 0.1-mfd. 500 V wkg. (T.C.C.).

For the time base:

- 1 5-way group board (Bulgin).
- 2 octal chassis mounting sockets. (Clix).
- 2 5-pin chassis mounting sockets. (Clix).
- 1 8-way plug and socket. (Bulgin).
- 1 Twin socket (or separate sockets) (Belling-Lee).
- 2 1.0-meg. variable resistances (Dubilier).
- 2 50,000-ohm variable resistances (Dubilier).
- 2 2-meg. 2-watt resistances (Bulgin).
- 2 2.0-meg. $\frac{1}{2}$ -watt resistances (Bulgin).
- 2 1,000-ohm $\frac{1}{2}$ -watt resistances (Bulgin).
- 2 1,000-ohm 1-watt resistances (Bulgin).
- 2 20,000-ohm $\frac{1}{2}$ -watt resistances (Bulgin).
- 2 0.1-mfd. tubular condensers (Bulgin).
- 1 0.5-mfd. tubular condensers (Bulgin).
- 1 0.0005-mfd. mica condenser (T.C.C.).
- 2 0.005-mfd. mica condensers (T.C.C.).
- 4 50-mfd. electrolytic condensers 12 volts (Bulgin).

These components do not include the condensers and resistances for the synchronising circuit as these are better determined when the receiver is finally connected. In the meantime a start can be made with the values given above, which are not likely to require alteration. They should be compared with the circuit diagram of Fig. 1.

Read

Television & Short-wave
World

Regularly

OCTOBER, 1937

BAIRD SCANNING EQUIPMENT AND CATHOVISOR TUBE

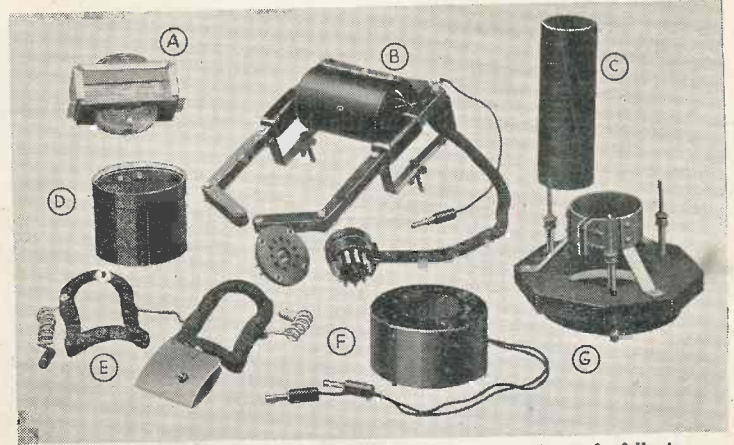

Baird scanning equipment. The letters on the photograph indicate the following units: A, Line scan generator; B, Frame yoke; C, Screening tube and holder; D, Screen; E, Line deflector coils; F, Focus coil; G, Adjustable holder.

THE Baird Company have available a complete scanning equipment for use in conjunction with magnetically focused cathode-ray tubes. This equipment comprises the line deflector coils, the line scan generator, the focus coil, screening tube and holder, and frame yoke.

Line Deflector Coils

The special features of the line deflector coils are as follows:

1. The maximum efficiency of beam deflection for a given input from the line generator is obtained by a patented construction employing a specially designed screen assembly. This confines and directs the magnetic field, reduces external leakage flux, and results in the greatest uniformity of distributed field along the deflection axis.

2. The initial alignment adjustments are very simple to carry out.

3. A neutralising condenser is supplied to cancel out any small oscillatory electrostatic potentials between the coils. This is arranged as an easily adjusted preset control, and correct adjustment results in a uniform horizontal trace.

A valve similar to the Cossor 41MP is utilised as an oscillator in the scan generator circuit. The coils are supplied with a metal screen, elastic coil retaining assembly and colour coded leads.

Line Scan Generator

This transformer is designed for use in conjunction with the line deflector coils, and when used in a circuit utilising suitable constants a most efficient means is readily available for generating a saw tooth cur-

rent wave form for scanning. Due to the special core and windings used, the transformer will handle efficiently the very high frequency harmonics necessary for the production of the saw tooth scanning cur-

features, one of which is a special metal screen which serves to increase the coil efficiency and gives improved field symmetry, while acting as a protective cover to the winding.

To ensure the utmost reliability of the coil a specially developed paper interleaved winding with bitumen impregnation is used, which results in a compact coil with a very uniform magnetic field having minimum leakage flux. The coil is proportioned to produce minimum spot size with least distortion.

The technical details of the coil are as follows:—

Total wattage consumed not more than $2\frac{1}{2}$ watts.

Current 11 m. amps. at 210 volts, for which the coil is designed to operate most efficiently.

Total ampere turns 350.

Coil resistance 19,000 ohms (approximately).

The Baird Company have now available complete scanning equipment for use in conjunction with magnetically focused tubes. This article gives the details and particulars of the 15-in. Cathovisor tube.

rent required in reception of television.

Focus Coil

The focus coil is designed to converge the cathode-ray beam to a point focus on the screen of the tube with maximum efficiency. The coil utilises several unique design

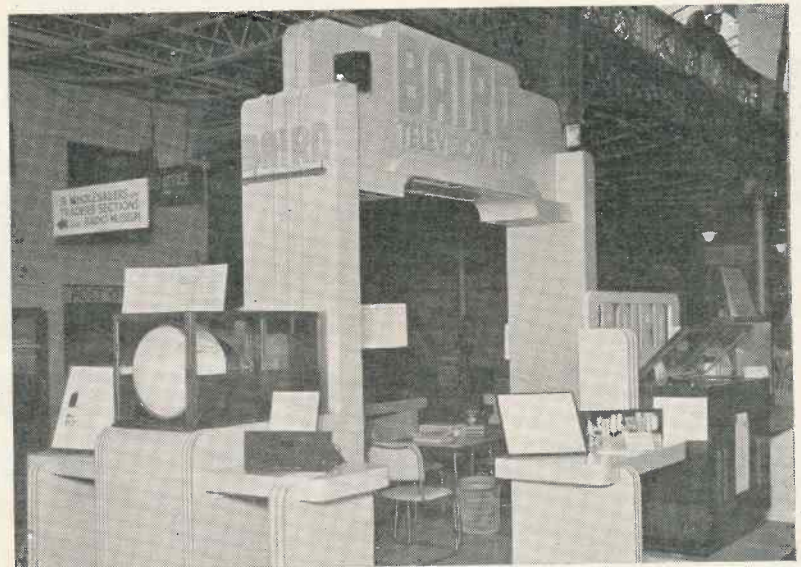

The Baird exhibits at Radiolympia. In the foreground is the largest cathode-ray tube ever made.

**Screening
Tube**

It has been found desirable to shield the electrode assembly in the lower portion of the tube from stray magnetic fields such as those pro-

duced by mains transformers, in order to reduce hum deflection of the cathode-ray beam to a minimum. The screen illustrated has been designed for this purpose. A specially prepared high permeability metal alloy is utilised, carefully proportioned to give the best results. A tube-fixing bracket is supplied for attachment to the lower portion of the focus coil holder, if used.

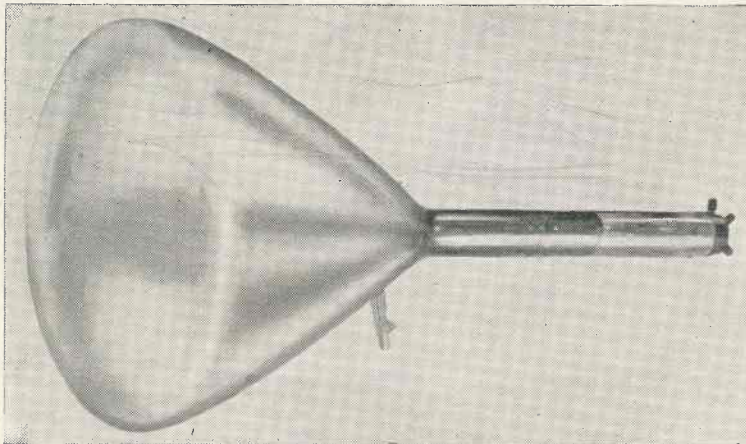

The Baird 15-in. magnetically focused cathode-ray tube.

duced by mains transformers, in order to reduce hum deflection of the cathode-ray beam to a minimum. The screen illustrated has been designed for this purpose. A specially prepared high permeability metal alloy is utilised, carefully proportioned to give the best results. A tube-fixing bracket is supplied for attachment to the lower portion of the focus coil holder, if used.

**Frame
Yoke**

The frame yoke unit comprises the deflecting and oscillatory circuits necessary to produce the vertical or frame scan on the screen of a cathode-ray tube. A common magnetic circuit is used for oscillation and deflection, and this produces a compact unit of high efficiency.

The laminated arms are fitted with adjustable extension pieces and these enable trapezium distortion of the scanning field to be avoided. The yoke is designed for most efficient operation at 50 frames per second, and utilising the recommended circuit (which may be obtained on application), in conjunction with the correct valve, the unit will be found simple to set up and adjust to give satisfactory results.

The Baird Cathode-Ray Tube

The requirements of a cathode-ray tube are the formation of a high intensity electron beam under the

influence of a suitable anode voltage. This is effected by the correct design of the electrodes, which involves the following: the optimum focusing of the beam so that the resultant screen spot is no larger than is necessary for the degree of picture definition used; the beam deflection being arranged so that the scanning field formed on the screen is both rectangular and linear; together with the beam modulation being arranged so that the resulting spot intensity can vary from black to white through all the half-tone values in accordance with the modulation derived from the received signal. Coupled with these electronic conditions are the important practical points of mechanical strength, long working life and freedom from screen flaws and inequalities.

These factors are complied with in the Type 15 WM2 "Cathovisor" cathode-ray tube. The electrode system is extremely simple and robust and, due to the type of cathode employed and the magnetic focusing, a high intensity cathode-ray beam is produced which results in a very brilliant picture. Screen grain does not impose a limit on spot size due to the special grading of the material used, and picture definition is outstandingly good. The screen is bound to the glass face by an exclusive process which makes it impossible for any powder to come off and fall into the electrode system.

Another special feature of the Baird tube is the relative flatness of the screen face, which reduces pin-cushion distortion to a minimum, while at the same time maintaining a high safety factor for the bulb. This has been brought about by a very careful design of the complete bulb shape and thickness distribution of

the glass so as to withstand the stresses involved. The glass bulbs are tested to withstand 3 atmospheres external pressure for ten minutes after being annealed.

The "Cathovisor" cathode-ray tube, Type 15 WM2, has a hard glass bulb with a screen diameter of 15 ins. (38 cms.), total length 33½ ins. (85 cms.), and a neck diameter of 1½ ins. (4.13 cms.). This gives a picture size of 12 ins. (30 cms.) by 10 ins. (25.4 cms.), without distortion.

The technical data concerning this tube is as follows:

Heater volts, 2.2 volts approx.

Heater amps., 2.5 amps.

Peak to peak volts, between black and highlights, 20 volts.

Maximum electro-magnetic sensitivity, 2mm/AT.

Modulator/earth capacity, 2 µµF (approx.).

Modulation sensitivity (slope) 17 µA/V (approx.).

Anode volts, 7,000 volts max.

Maximum input power to the screen, 3.5 milliwatts/sq. cm.

Screen colour, black and white.

The tube is completely electro-magnetic in operation.

Dubilier Condensers and Resistances

We have received from the Dubilier Condenser Co., Ltd., of Ducon Works, Victoria Road, North Acton, W.3, a copy of their latest catalogue of condensers and resistances. A very wide range of these components, including the most popular standard designs of interest to the home constructor and service engineer, is listed, together with full particulars and prices. The catalogue includes a useful resistance calculator, by means of which any two unknown values of potential, resistance, current or power can be ascertained providing two quantities are known. Copies of this catalogue may be had upon application to the above address and mention of this journal.

One of our subscribers in Washington, U.S.A., is anxious to obtain a copy of TELEVISION, dated April, 1929 (now out of print). Will any reader who can supply this copy send a post-card (stating price) to Mr. R. S. Ould, 3747 Huntington Street, Washington, D.C., U.S.A.

Telegossip

By Lumen

THE flow of technical books has begun and in a year or two it will be in full spate. After Pitmans' two heavy guns—Myers' "Television Optics" and Wilson's "Television Engineering," we can expect something big in the way of a counter from their friendly rivals Chapman & Hall. I hear rumours of a book from the Baird camp.

The principal objection to technical books is their cost and the space occupied by them! I have a row of them already and look forward with gloom to the time when I shall have to discard some of the old friends to make room for the up-to-date ones. And the trouble is that one never knows when an old book will be just the thing for an obscure historical reference. One of the most valuable books in my small library is Thompson's "Discharge of Electricity through Gases," although the date is 1898. And while on the subject of old books, let me recommend you by hook or by crook to get hold of copies of "Light Visible and Invisible," by Silvanus Thompson, and "Elementary Lessons in Electricity and Magnetism," by the same author. Their style is so lucid they are a joy to read, and it is surprising the amount of information they contain.

We are pushing on so fast nowadays that we are apt to forget a lot of fundamentals, and ten minutes with these occasionally are as good a refresher as one could wish for.

Sight Without Sound

The G.E.C. baby receiver which operates on vision only reminds me that for the first few weeks on my own set I looked without hearing, due to some interference on the sound side. It was not such a disadvantage as might be supposed. The films were quite satisfying and the only time when the sound was really missed was in the plays. So if the B.B.C. decide to economise they can still dig up some silent films without losing all their audience.

That Fault

Have you noticed the black spot on the film scanning camera—it may be gone by now as I have not looked

in for a week or so, but it was there for some time before and during the Radio Show.

It must have caused some heart-burnings when it first appeared and sent many lookers hunting for obscure faults or cursing tubes for developing bad patches on the screen! To one looker it was a blessing in disguise as it showed up a trace of phase distortion which was unnoticed in the general run of pictures. The edge of the spot had a tiny rim of white which disappeared when the receiver was overhauled.

Non-skid

A friend of mine has a receiver (no free advertisement!) which he says has never slipped a frame since it was installed. Is this a record? He rather spoils it by adding, "Of course it may have slipped when I wasn't looking." Is he going to become one of those maniacs who switch on a set and leave it running all the time regardless of whether he is looking at it or not? We have had them for years in the sound broadcasting—surely they are not going to carry their evil habits into television.

Continued Progress

Each time that I see demonstrations of mechanical-optical systems I become more convinced that the time is not far distant when they will achieve results equal to electronic methods. In the laboratory they are the equal, but there are one or two difficulties to be overcome before apparatus of this kind can be placed in the hands of the public. With the introduction of cathode-ray projection receivers it might appear that one of the chief advantages of a mechanical system—its ability to produce large pictures—has gone, but this by no means follows for the technical difficulties associated with really large screen work by means of the cathode-ray tube appear greater than in the case of mechanical-optical methods.

It is really amazing to note the amount of simplification that has taken place of late in the design and layout of mechanical receivers. But a few months ago they appeared as

complicated assemblies of apparatus which it was difficult to imagine could be housed in any size of cabinet suitable for the home. Reduction of scanner size and careful attention to layout, however, has achieved wonders. I was very much impressed with this point recently when I witnessed a demonstration of reception by the Mihaly-Traub receiver. This, it should be noted, was reception from the Alexandra Palace, and the picture was approximately 20 in. by 16 in., the entire apparatus being housed in a cabinet of about the same size as the average cathode-ray receiver. The pictures were bright and clear, the only defect being a lateral movement of the picture as a whole which took place at irregular intervals. The elimination of this trouble will not present any serious difficulty.

So far as I am aware no amateur attempts to construct a mechanical-optical receiver have been made since the 30-line transmissions ceased, but a careful examination of this receiver showed that there are distinct possibilities and that the work would be most fascinating. Admittedly, it would not be simple, but it would be quite within the ability of those who have well equipped workshops and are capable of reasonably accurate work. If there are any amateurs who have done any work in this direction it will be interesting to hear of their experiences.

A Point to Note

Having occasion recently to dismantle my aerial with which a concentric feeder is used, I was amazed to find that the feeder contained about half a pint of water. On the face of it this was surprising, for examination of the upper end of the feeder showed that it was most carefully sealed with some bitumen compound, and the lower end, of course, was indoors and therefore protected from the weather. The only explanation is that the water had accumulated by condensation and that it had lodged where the feeder made a downward loop. Anyhow, there was no question of its presence or the amount and it seems surprising that it had not affected reception; as a matter of fact no falling off had been noticed though it would seem that any further accumulation would have been bound to have had an adverse effect. The matter is worthy of investigation by those who have used this type of feeder.

THE TELEVISION RADIO LINK

DETAILS OF THE SYSTEM USED BY THE R.C.A.

AN account of the recent television activities of the National Broadcasting Company (U.S.A.) in collaboration with the Radio Corporation of America was given in our May issue. It will be remembered that the studios are located in the R.C.A. Building,

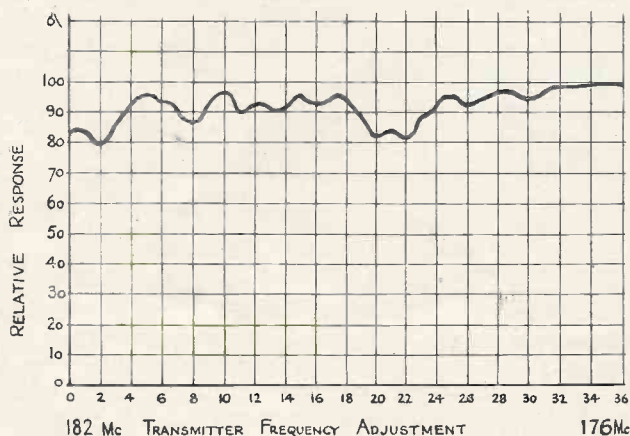

Fig. 1.—Variation of received signal—horizontal one wavelength transmitting antenna at 14th floor level; receiving antenna, two horizontal $\frac{1}{2}$ -wave dipoles end to end spaced $1\frac{1}{2}$ wavelengths between centres.

Radio City, and the transmitter in the Empire State Building, which is approximately 4,600 feet distant. It was necessary, therefore, to provide a connecting link to carry the video frequencies from the studios at Radio City to the transmitter.

Actually both a coaxial cable and radio circuit are used for this link, but it is the latter with which this article is concerned.

The radio link operates on a carrier frequency of 177 mc. which was chosen to be clear from harmonics of the picture and sound transmitters operating in close proximity to the relay receiver. A high frequency was chosen to be free from interference on existing radio services, to allow directive antennas to be used in which space was a limiting factor, and to take advantage of the lower man-made noise level encountered from sources such as elevator contactors, motors, etc. Valves now available make operation above 200 mc. difficult. Ultra high-frequencies are particularly adaptable to distances of this sort, and to the wide modulation band required.

Propagation Tests

The video frequencies up to 1,500 kc. to be transmitted require the radio circuit to carry a band of 3,000 kc. with double side band transmission. Calculation showed that the combination of the direct and reflected rays at the receiving antenna could cause serious variations in transmission efficiency throughout the extremely wide band, depending upon the location of the points of reflection, and the intensity of the reflected ray or rays.

To obtain more accurate information regarding this

variation in transmission efficiency, propagation tests were carried out over the band of 176 to 182 mc. The results of these tests showed that a reasonably flat response could be obtained by using transmitting and receiving antennas having moderate horizontal directivity. Fig. 1 shows the response curve obtained with a directive transmitting antenna located at the 14th floor level of the R.C.A. Building and a directive receiving antenna at the 85th floor of the Empire State Building.

The antennas now in use at each end of the circuit are electrically equivalent to each other and consist of a one wavelength horizontal radiator, fed at the middle, located in front of a metal reflector. Fig. 2 is a diagram of the transmitting antenna now in use. These antennas are sufficiently broad to pass, without appreciable attenuation, the 3,000 kc. band.

Transmitter

Fig. 3 shows the radio and video-frequency units of the transmitter. A schematic diagram of the complete transmitter is shown by Fig. 4.

The master oscillator, right hand compartment of Fig. 3, consists of two R.C.A.-834 type valves operating in push-pull at a frequency of 177 mc. The frequency of the oscillator is determined by a low power factor concentric resonator to which the grids are inductively coupled. The grid loops which are coupled to the frequency control circuit are in opposite polarity so that the phase of the grid voltages differ by 180° .

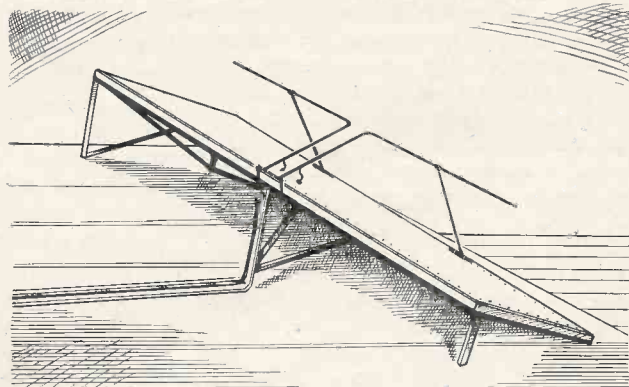

Fig. 2.—Transmitting antenna at 14th floor level.

The ratio of the diameters of the concentric conductors of the frequency controlling circuit is 3.5. A theoretical Q of 11,370 is obtained with an inside conductor diameter of 2.25 in.

By means of special arrangements the resonant frequency of the low power factor circuit is made substantially independent of temperature.

The master oscillator has adjustable impedances in its plate and filament circuits. The grid circuit reactance was adjusted to about the required value by a short wire connected from grid to grid. This wire is in parallel with the grid loops which couple to the low power factor circuit. The plate inductance is a concentric conductor line connected from plate to plate.

OCTOBER, 1937

At the neutral point on this line the inside conductor is exposed so the power amplifier grid coil may be inductively coupled to it.

The drawing, Fig. 3, shows the master oscillator on the right hand side, the modulator in the centre, and the power amplifier on the left. With such an arrangement the connection from the modulator to the power

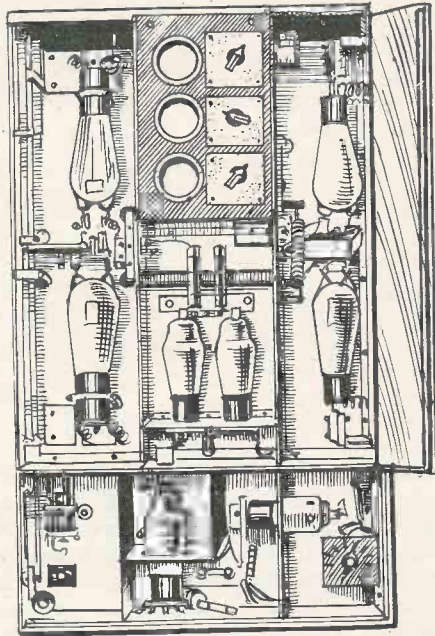

Fig. 3.—The radio and video-frequency units of the transmitter. Left, power amplifier. Right, master oscillator. Centre, modulator. Lower left, monitor. Lower right, modulator amplifiers.

amplifier grid circuit is short and the modulator output capacitance is reduced. However, this makes the link from the master oscillator to the power amplifier rather long. This link is the master oscillator plate inductance and its maximum reactance is fixed by the tube inter-electrode capacities. The correct inductance was obtained by the proper choice of the conductor diameters. A small balanced condenser connected from plate to plate is used for fine adjustment of the master oscillator circuit. Plate voltage is supplied to each tube through an r.f. choke.

The R.F. output stage is a conventional push-pull cross neutralised amplifier. The valves (two R.C.A.-834's) are located as shown in Fig. 3 to make the length of the connections from the grid and plate tube prongs to the neutralising condensers a minimum. This is necessary to prevent parasitic oscillations. The neutralising condensers are the horizontal concentric cylinders at the centre of the power amplifier compartment. The outside cylinders are connected to the plates and are made up of two telescoping tubes for adjusting the neutralising capacitance. The inside cylinders are connected to the grids. This arrangement reduces the stray capacity between the input and output circuits of the power amplifier.

The power amplifier grid circuit is an untuned inductance composed of a short brass strip connected from grid to grid, and closely coupled to the voltage nodal point of the master oscillator plate inductance. The centre point of the grid inductance is directly connected

to the modulator plates. By eliminating the blocking condenser between the modulator and the power amplifier the stray capacitance of the modulator output circuit to ground is reduced. Since the power amplifier grids are connected directly to the modulator plates they are maintained at a positive potential of 250 volts. To give proper operating bias the filaments are maintained at a positive potential of 400 volts by a filament return resistor.

To maintain the symmetry of the power amplifier output circuit the plate inductance is made of two balanced lines in parallel. Slides on these two wire lines are provided for approximate tuning of the power amplifier plate circuit, and a small two-plate variable condenser for the fine adjustment. One branch of the plate circuit is inductively coupled to a balanced 150-ohm load. The power amplifier will deliver to this load a 15-watt carrier.

The monitor step-down transformer is a concentric conductor line one-half wavelength long connected across the output terminals of the power amplifier. At the centre or voltage nodal point on this line a loop is inductively coupled to the inside conductor. This loop is connected to a rectifier which is used to monitor the transmitting R.F. output.

The modulator uses two R.C.A.-802's in parallel. The frequency response curve for each video frequency stage is made flat. The phase shift produced by the resultant plate impedance is proportional to frequency over the transmission band and, hence, does not produce phase distortion. The attenuation and phase shift produced at the low frequencies by the interstage coupling and cathode by-pass condensers are compensated for by choosing a suitable value of plate supply by-pass capacity. The plate supply of each stage has a series resistance or damped reactor to isolate it from the power supply.

The modulator amplifier consists of two stages, an R.C.A.-802 and R.C.A.-6C6. An output level of .45-volt r.m.s. is required to modulate the transmitter 85 per cent.

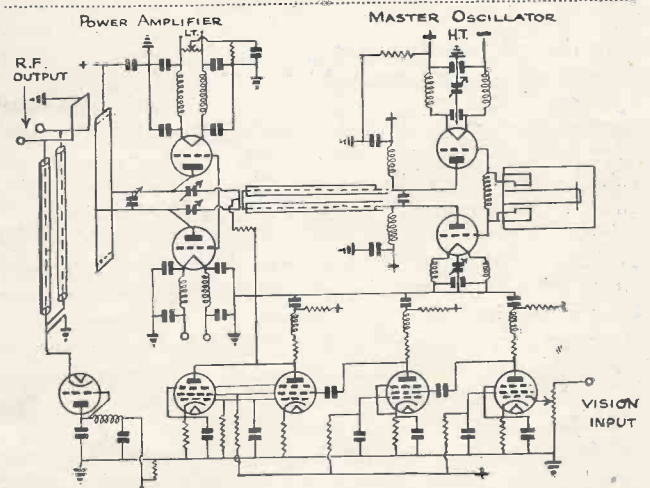

Fig. 4.—Schematic diagram of complete transmitter.

The impedance matching circuit is shown by Fig. 5. It is adjusted to step the antenna input load down to 166 ohms at 177 mc. This is necessary to give maximum efficiency and flat frequency response over the band used.

Receiver

The receiving antenna on the 85th floor of the Empire State Building is approximately 100 ft. from the receiver location. The antenna feed line is composed of two 76-ohm, 13-gauge, coaxial cables, located in a con-

necessary to provide an indicator to show when the signal carrier is tuned to mid-band. This indicator allows the operator easily to find the correct setting of the local oscillator. A 0-1.5 M/a. meter on the front panel shows the plate current of a biased triode detector, which is excited by a high C resonant circuit

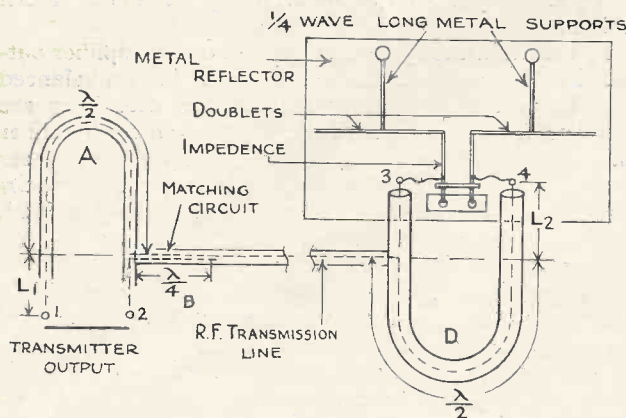

Fig. 5.— Balanced to unbalanced transfer circuits transmitting line and transmitting antenna.

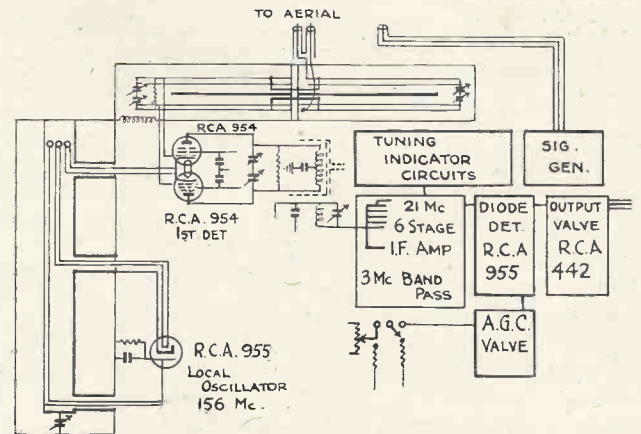

Fig. 6.— Schematic diagram of receiver.

duit running from the receiver rack to the back of the antenna reflector. The use of two cables gives in effect a balanced, shielded, 152-ohm transmission line. Special tests were carried out properly to match the antenna to the feed line at 177 mc. to get the greatest overall efficiency and flattest response with frequency. The transmission line loss was estimated to be not more than 1.9 db. With all adjustments made the cables were sealed off, evacuated, and filled with dry nitrogen under pressure. This process insures the removal of moisture from the cables, and gauges permanently installed show whether the pressure is maintained.

Fig. 6 shows a schematic diagram of the receiver. A balanced concentric line type band-pass transformer, receives 177 mc. energy from the balanced coaxial feed line. The transformer in turn feeds a balanced heterodyne detector consisting of two R.C.A. 954 acorn valves whose cathodes are excited by a concentric line type of local oscillator operating at 156 mc. The intermediate frequency of 21 mc. appears push-pull in the output of the balanced detector stage and is coupled to a single ended 6-stage, band-pass amplifier using coupled circuit transformers. The overall flat band width is 3 mc.

The I.F. amplifier is fed to a linear diode rectifier (R.C.A. 955), which in turn feeds the R.C.A. 42 output valve. Video frequencies are carried from the receiver over a coaxial cable to the transmitter line amplifier.

Automatic gain control of the I.F. amplifier is accomplished by means of a D.C. amplifier driven from a voltage divider across the diode load resistance. This circuit is arranged to feed variable negative control voltages to two valves in the I.F. amplifier. A switch is provided to allow the gain to be controlled manually. A set of switches on the front panel allows the plate currents of the I.F. amplifier valves to be checked on one meter without interrupting the operation of the receiver. The other plate currents with the exception of the automatic gain control valve are shown continuously on individual meters.

Due to the extreme width of the I.F. amplifier it is

having fairly high Q. This resonant circuit is driven by an R.F. pentode fed from the I.F. amplifier. A push-button is arranged to connect a small fixed capacity across part of the resonating inductor, and the resonant frequencies with the push-button out and in are set to be equally spaced about I.F. mid-band. With such an arrangement the tuning indicator meter (0-1.5 M/a.) in the plate circuit of the biased detector will show no change with the push-button out or in when the carrier is accurately tuned to mid-band.

A separate regulated power supply having an effective internal resistance of less than one ohm is used to supply power to the R.C.A. 42 output valve. Thus, objectionable low-frequency resonance often occurring

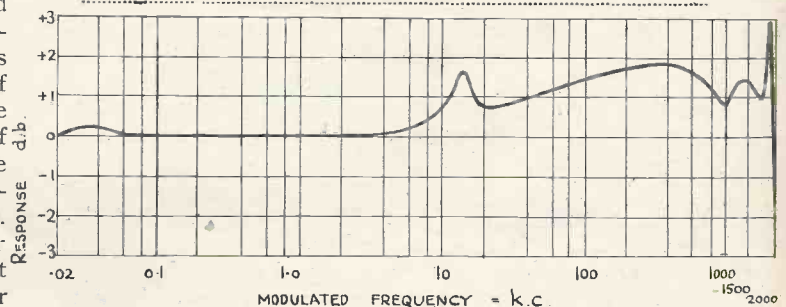

Fig. 7.— Overhaul frequency characteristics of the radio relay.

in ordinary power filters is eliminated, which permits a flat frequency response to be obtained down to 10 cycles or less with the output valve working into a load resistance of only 100 ohms.

In a receiver of this sort having a tuned band-pass input transformer at signal frequency, the problem of properly tuning these two circuits presents itself. The correct tuning to give a flat band pass is not necessarily that obtained by setting each dial for maximum response in the usual way. This problem is overcome by supplying in the receiver rack a shielded oscillator to

(Continued on page 610)

RECENT TELEVISION DEVELOPMENTS

A RECORD OF PATENTS AND PROGRESS *Specially Compiled for this Journal*

Patentees :- Baird Television Ltd. and G. W. White :: Marconi's Wireless Telegraph Co., Ltd. and G. M. Wright :: Standard Telephones and Cables Ltd. :: Radio Akt. D. S. Loewe :: J. E. Keyston

Television Transmitters (Patent No. 466,715.)

IN a television transmitter the picture signals and the synchronising impulses are superposed on the carrier wave, at the same point in the chain of amplification, by applying them to different electrodes of the same valve.

As shown in the figure the carrier wave is applied at A to the control grids of two valves V, V₁ arranged in push-pull. The picture signals, from a source P, are applied in parallel through a tapping T to the same grids, whilst simultaneously synchronising signals from a separate source S are applied, also in parallel, to the screen grids of the same valves.

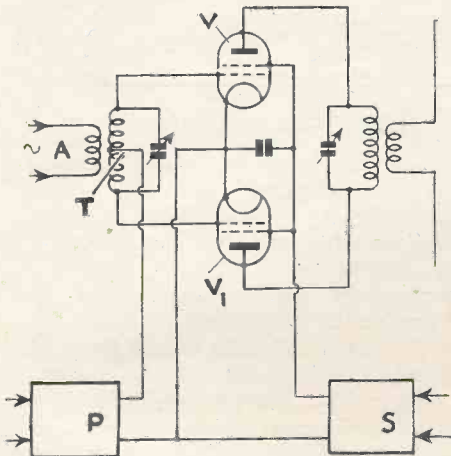

Separation of picture and synchronising signals in transmitter. Patent No. 466,715.

In this way the two sets of signals are kept completely separate up to the point of modulation.—*Baird Television, Ltd., and G. W. White.*

Projection Tubes (Patent No. 467,918.)

Instead of showing the picture on the fluorescent screen of a cathode-ray tube, it is projected on to an external viewing-screen where the usual restrictions as to size do not apply.

As shown in the figure, the end of the bulb of a cathode-ray tube T is fitted with a glass prism P, through which light from an external source

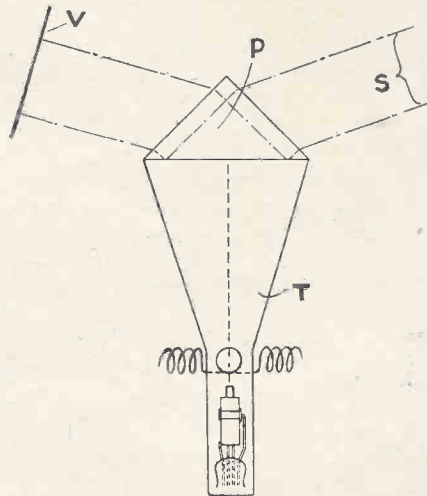

Projection tube making use of external light source. Patent No. 467,918.

S passes on to an external screen at V. The direction from which the ray enters the prism is such that it strikes the lower surface of the prism P at or about the critical angle of internal reflection.

The impact of the electron stream, as it moves across the glass of the prism in scanning is stated to vary the critical angle of reflection so that the amount of light which is reflected depends upon the intensity of the stream. In other words, the emergence is modulated in accordance with the incoming signals as applied to the control grid of the tube. This produces an image of the original picture on the external screen V.—*Marconi's Wireless Telegraph Co., Ltd., and G. M. Wright*

Time Base Circuits (Patent No. 467,958.)

To generate saw-toothed oscillations, suitable for scanning, it is usual to charge up a condenser

through a high resistance, and to discharge it periodically through a gas-filled tube of the Thyatron type.

According to the invention the charging resistance consists of a pentode valve so arranged that the control grid, the accelerating grid, and the suppressor grid are all subjected to a bias which is varied with any change in the strength of the current passing through the valve. This serves to keep the charging-current constant at all times.—*Standard Telephones and Cables, Ltd.*

Cathode-ray Tubes (Patent No. 467,995.)

The fluorescent screen F of the cathode-ray tube is deposited on the inner wall of the glass bulb, as shown, and a magnifying-lens L is attached to the outer wall of the bulb. The curvature of the lens is the same as that of the glass bulb over the surface of contact, but its outer side is more sharply curved, so that it

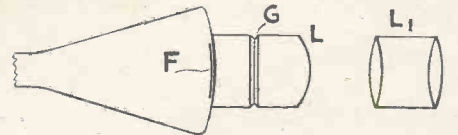

Projection by means of lenses. Patent No. 467,995.

minimises spherical aberration. Actually, the virtual image produced by the lens L has a concave curvature so as to compensate for the convexity of the fluorescent screen.

A groove G is formed around the surface of the lens L, about midway along its length, with the object of reducing total internal reflection of the light, such as might tend to produce "ghost" images of the picture. A projection lens L₁ is interposed between the lens L and an external viewing screen.—*Marconi's Wireless Telegraph Co., Ltd., and G. M. Wright.*

The information and illustrations on this page are given with permission of the Controller of H.M. Stationery Office.

Tuning Controls

(Patent No. 468,437.)

The cabinet of a television receiver is arranged so that the front panel carries only two control knobs, both of which may have a second coaxial shaft. One operates the on-and-off switch, and then cuts out an anode resistance, as the control is further rotated, so as gradually to increase the light intensity. The other knob controls the tuning, and is linked with an indicator marked "sound only," "picture only" and "picture and sound."

The other control knobs, which do not usually require readjustment, are mounted on the back of the panel. These include line-frequency and frame-frequency adjusters, means for regulating the amplitude of the synchronising impulse, and means for intensifying the sharpness of the image point.—*Radio-Akt. D. S. Loewe.*

Television Transmitters

(Patent No. 468,483.)

There is a known type of cathode-ray transmitter in which a primary scanning-beam of electrons is used to set up a secondary beam or "cloud," which then acts on a mosaic screen of photo-electric cells to produce currents representing the light-and-shade values of the picture to be televised.

In a system of this kind, a thin sheet of metal, adapted to give a copious supply of secondary emission, is interposed in the path of the electron stream, just before the mosaic electrode, so that the secondary electrons pass on to the sensitive mosaic surface instead of the primary stream. In this way, the sensitised surface is protected from damage, and possible disintegration, by the impact of the high-speed primary electrons.—*Standard Telephones and Cables, Ltd.*

Electron Multipliers

(Patent No. 468,623.)

An electron-multiplier tube is fitted with two parallel "target" plates, which are arranged at both sides of a thin cylindrical anode and are fed with an alternating voltage from an outside source. The electron stream to be amplified is projected on to the tube through an aperture in one of the plates, and is then caused to strike first against one and then against the other of the two parallel plates. At each impact, secondary

electrons are emitted and go to swell the original stream, so that the strength of the output current finally collected by the anode depends upon the number of impacts made by the stream before it reaches the anode.

This, in turn, depends upon the angle at which the stream is first allowed to enter the tube. According to the invention, this is controlled by means of two deflector plates which are arranged just outside the aperture and are supplied with a control voltage in order to deflect the stream as it passes into the multiplier tube. In this way the stream may be arranged to make two, three, or four impacts, according to the degree of amplification required.—*J. E. Key-ston.*

Summary of Other Television Patents

(Patent No. 465,763.)

Cathode-ray tube in which the electrode system is mounted, in combination with a focusing coil, on a single support of ceramic material.—*N. V. Philips', Gloeilampenfabrieken.*

(Patent No. 465,892.)

Method of supplying operating-voltages, both to a cathode-ray tube and its associated time-base oscillator, from a common source of supply.—*Baird Television, Ltd., and L. A. Merdler.*

(Patent No. 465,966.)

Scanning system for use with a television transmitter of the image-dissector type.—*The British Thomson-Houston Co., Ltd.*

(Patent No. 465,970.)

Means for phasing the synchronising motor in a mechanical scanning system.—*E. Traub.*

(Patent No. 466,031.)

"Light" valve which depends for its effective transferences upon the variable adhesion between minute particles of mica.—*Marconi's Wireless Telegraph Co., Ltd.; L. M. Myers and E. F. Goodenough.*

(Patent No. 466,046.)

Correcting for distortion of the electron stream through a cathode-ray tube which is liable to occur when the filament of the tube is heated by alternating current.—*E. Michaels.*

(Patent No. 466,426.)

Method of making cathode-ray

tubes with thin-walled glass necks.—*Baird Television, Ltd., and A. H. Johnson.*

(Patent No. 466,508.)

Film-scanning system designed to increase the intensity of the light available for producing synchronising-impulses.—*Radio-Akt. D. S. Loewe.*

(Patent No. 466,826.)

Cathode-ray tube fitted with concave deflecting-plates in order to prevent picture distortion.—*E. Ruska.*

Patent No. 467,838.)

Process for making the "mosaic" photo-electric screens used in cathode-ray television transmitters.—*Marconi's Wireless Telegraph Co., Ltd.*

(Patent No. 467,916.)

Rectifying circuit for separating the picture signals from the synchronising-impulses in a television receiver.—*Radio-Akt. D. S. Loewe.*

(Patent No. 468,146.)

Photo-electric cell in which a central electrode is surrounded by a grid-like anode which produces secondary emission.—*The General Electric Co., Ltd., and C. H. Simms.*

(Patent No. 468,191.)

Television system in which all the picture points contained in one scanning line are reproduced simultaneously.—*F. von Okolicsanyi.*

Lectures on Television

A series of lectures on television have been arranged at the following educational centres. They are now commencing, and intending students should join without delay. Further particulars can be had from the Principals.

Borough Polytechnic, Borough Road, London, S.E.1. A sessional course; held on Thursdays, 8-9.30 p.m. Sessional fees for students under 18, 10s., over 18, 20s. Certificates granted to students who pass the examination at the end of the course.

Morley College, 61 Westminster Bridge Road, London, S.E.1. Courses of twenty-four lectures (Elementary and Advanced). On Friday evenings, Elementary 7-8.30 p.m.; Advanced, 8.30-10 p.m. These courses afford students an opportunity to become acquainted with experimental research that has made television possible including principles now applied. Fee 7s. 6d. and entrance fee 3s. 6d.

The information and illustrations on this page are given with permission of the Controller of H.M. Stationery Office.

OCTOBER, 1937

A NEW SYNCHRONISING CONTROL SYSTEM

Developed by PAUL D. TYERS

THE reception of a high-frequency carrier wave modulated at video frequencies presents no more difficulties than one modulated at audio frequencies. The fact remains, however, that the handling and adjustment of a normal vision receiver is far more complicated than that of a sound set. It was this fact that led the writer to undertake a considerable amount of research into the subject of scanning and synchronising control almost totally independent of the received carrier strength it is obvious that the initial

chronising control almost totally independent of the received carrier strength it is obvious that the initial

This article explains the scanning and synchronising control system employed in the low-cost television receiver described on other pages in this issue.

synchronising impulse must be derived from some circuit which has a positive datum line and furthermore

that the absolute magnitude of the received carrier wave can vary quite appreciably without any possibility of a voltage being produced across the diode load due to picture modulation. It will be obvious, however, that the magnitude of the pulse may still vary.

Now any time base device subjected to a control impulse is dependent upon the magnitude of that impulse and accordingly variation in carrier output would affect the time base. Therefore it is necessary to introduce some other feature which will give a constant pulse.

The proportion of the separated synchronising pulse which itself is of quite low magnitude is applied to a valve having an extremely short grid base so that only a portion of this pulse is again amplified. This is shown diagrammatically in Fig. 2. It will be seen that the portion of the derived impulse can diminish quite appreciably, whilst it can increase to an infinite value without in any way affecting the output of the limiting valve. (This circuit combination then delivers a synchronising impulse of constant magnitude.

This arrangement when applied to an ordinary scanning circuit will give control which is really independent of

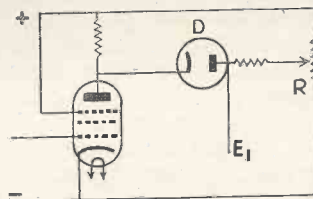

The potentiometer R is adjusted so that D conducts below black level

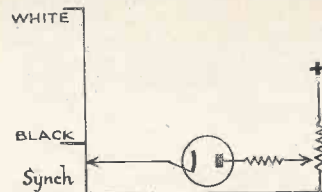

ising means with a view to producing something which had a far greater inherent degree of stability and required far less attention than a receiver operating according to normal practice.

The system developed seems to satisfy these requirements because the control of the picture on the screen is sensibly independent of very large variation in signal strength, it is not readily upset by interference and it is immune from the effect of quite wide variations in the constants of the circuit in the scanning arrangement. In an ordinary synchronising and scanning system when the line and frame speeds are incorrect, the picture breaks into unrecognisable elements whilst there is a continuous roller blind effect in the frame direction. In the writer's system neither of these effects occur, the picture merely folding up if the adjustment is totally incorrect. If line and frame controls are provided the picture is readily brought into correct shape because it is always visible no matter how badly adjusted may be the line of frame scan. These results are obtained not by one factor alone, but by the combination of three distinct features.

If it is desired to make the syn-

only a portion of the pulse must be utilised. The simplest method of utilising only a portion of the synchronising impulse is to employ some form of biased unilateral conductor. That most suitable appears to be an ordinary diode. Most receivers employ a video stage and therefore a very convenient method consists of connecting the diode between the anode of the video stage and a suit-

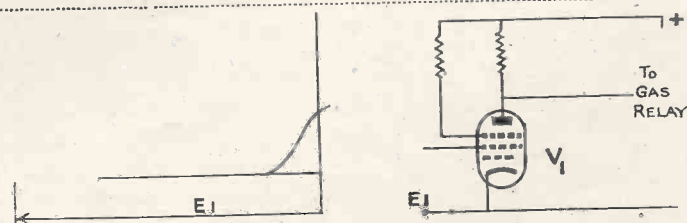

The negative synch pulse of magnitude E, is applied to the short grid base of the limiter valve V1.

able voltage level obtained from a potentiometer across the H.T. supply. (This is shown in Fig. 1. The potentiometer is adjusted so that the diode conducts not at the black level, but at a value considerably below the level. This arrangement will function during the synchronising impulse which will give an output across the diode load proportional to only a portion of the pulse. This means

the variations described, but at the same time it was felt that this was not enough because ordinary gas discharge time base circuits are very sensitive to changes in the constants of the valves and also small changes in the network.

This difficulty was overcome by operating the gas discharge relay in the following manner. The gas discharge valve assumes a very low im-

pedance at the discharge or ignition voltage. The critical zone on a modern argon or helium filled tube is a matter of a few volts. Changing the constants of the resistance, condenser or line voltage will therefore affect the firing point of the tube. But it is always very near to this zone that the ordinary synchronising pulse is applied to the control grid of the tube, when exceptionally stable running is obtained.

Experiments showed that if the synchronising impulse is applied outside the normal critical zone, quite wide variations can be made in the constants of the valves and the general network. It is very important not to apply too strong an impulse to a gas tube as otherwise many difficulties may arise. Further experiment showed that a suitable control voltage on the grid would shift the critical zone. Moreover, in order to obtain stable operation this voltage had to be exceptionally constant.

The other part of the circuit described gives a voltage of exactly the required form. (The charge time of the condenser is adjusted so that the correct voltage is obtained while the anode is outside the critical zone. At this instant the synchronising voltage

is applied to the grid. The absolute magnitude is relatively greater than usual but the effect is just as weak as a smaller impulse applied in the normal critical zone. The result is that very large variations can be made in all constants and one gas tube can be substituted for another without in any way affecting anything. For all practical purposes therefore the system obviates the necessity for line or frame controls.

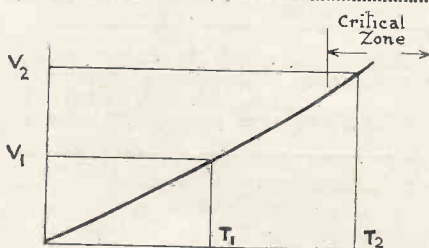

The Gas relay at time T_2 reaches an anode voltage V_2 which lies in the critical zone. Voltage E_1 reversed in phase and limited is applied at T_1 which brings the critical zone down to the region of V_1 and fires the tube.

The above description may give the impression that it is exceptionally easy to produce a scanning and control system on the lines described. Actually the reverse is the case and

unless everything is perfectly correct difficulty is experienced in producing either a good line or a correct interlace.

Elsewhere in this issue a constructional article on a vision receiver appears which it is understood operates on the principle described. The writer has had no connection with the design of the set in question and the fact that the designer has been able to apply the system from only a brief description shows that the circuits are of definite practical value. It has been arranged with the Editor of TELEVISION AND SHORT-WAVE WORLD that the writer will give at a later date a full technical description of how to apply the system to a vision receiver in which all the relevant critical factors will be carefully discussed. It will be shown how the system can be applied so that it in no way affects the frequency characteristic of the amplifier or the form of the scan or the correctness of the interlace. It should be clearly understood that the application of the system introduces several factors which are not present in ordinary technique and accordingly it is necessary to make considerable alteration in standard methods of design.

"The Television Radio Link."

(Continued from page 606)

supply energy over a single coaxial cable to a point on the antenna reflector. The cable termination near the antenna includes a damping resistance, a small radiating rod, and a shunt inductance all combining to produce a correct terminating impedance over the band of frequencies used. With this arrangement the operator can vary the oscillator frequency over the receiver pass band and observe the shape of the (antenna-feed line-receiver) characteristic on the output of the receiver. With a few trials the correct tuning of the input transformer can be obtained. These adjustments may be made when the 177 mc. television transmitter is off the air. These circuits once set require little attention thereafter.

As might be expected a signal of considerable intensity is received at the Empire State Building. Calculation shows, that the transmitter power and antenna directivity used should result in a direct ray field strength of approximately 300 millivolts per metre at the receiving antenna. A strong signal is necessary to override local disturbing noises from elevator machinery, etc., which become more troublesome the wider the receiver band width. It might be mentioned that lightning flashes in the immediate vicinity give only moderate clicks in the receiver output.

Signal strength observations made so far show variations in intensity of only a few per cent., indicating that variations in rays reflected from the ground are unimportant.

Overall frequency characteristic measurements have been made from the transmitter input to the receiver

output over a range of from 20 cycles to 2,000 kc. Fig. 7 shows the result of these tests. The irregularities in the curve from 100 to 1,700 kc. are mostly caused by the propagation path as mentioned earlier. The peak at 1,800 kc. is produced by an equalising circuit in the receiver output. It will be observed that the maximum deviation over the desired band of 20 cycles to 1,500 kc., is 1.8 db., which occurs at 400 kc.

Signal to noise level measurements were made at the receiver using a measuring amplifier having an effective band width of 20 kc. These measurements showed a signal to noise level of 44 db. with 85 per cent. modulation at the transmitter. The noise level was almost entirely 60 and 120-cycle power supply hum.

Although the receiver is located near the high-power television broadcast transmitters, no trouble is experienced from interference. Pictures have been transmitted over this circuit without affecting their quality.

Yorkshire Television Association

THE Yorkshire Television Association's winter programme opened on Sunday, September 26, with a lecture on "Electron Optics," by A. Buckley, Morse instruction by E. Wood, A.M.I.R.E., and a loudspeaker demonstration by L. F. Virgo, B.Sc.

The following meeting will be held on October 24, when a lecture will be given by H. B. Hunt. Meetings are held monthly throughout autumn, winter and spring when non-members are cordially invited to lectures free. Cards of admission can be obtained from the secretary, A. Buckley, 110 Finkle Lane, Gildersome, Leeds.

STUDIO & SCREEN

A MONTHLY CAUSERIE

on Television Personalities and Topics

by K. P. HUNT

Editor of "Radio Pictorial"

RADIOLYMPIA was a tremendous publicity agent for television in general, and doubtless provided a new sales impetus which is so desirable.

Dodging in and out of the television booths during the currency of the exhibition, I heard many comments on the television shows, and the general impression, I think, was that the majority of visitors were amazed at the quality of the pictures. Many came to the exhibition prepared merely to be tolerant, expecting to see something in the nature of a scientific toy. But they went away realising that television has now taken its place among the other vehicles of entertainment in the country.

At the same time, I believe many people engaged in the industry, or connected with radio, fully appreciated the B.B.C.'s immense difficulties from a publicity point of view in presenting short programmes of only a quarter of an hour, for these really did not convey an adequate impression of the diversity of material now being televised in the regular programmes.

These demonstration broadcasts unavoidably were split up into short sections of about five minutes each, and naturally there was no sustained entertainment value. It should be realised, of course, that the B.B.C. did not pretend that these programmes were up to the standard usually broadcast for home viewers.

Of the whole Radiolympia programmes, probably the most appreciated was the Zoo material, which impressed all by its spontaneity and jollity. The grand finale, in particular, when the animals went into the ark two by two, was a splendid effort worthy of special congratulations to the Alexandra Palace staff.

* * *

The greater ease in working at Alexandra Palace which was anticipated when one standard of transmission was adopted, is now becoming apparent. There is much more elbow room in the studios, and things generally are nothing like so cramped as they were. The scenery can be

shifted about without so much difficulty, and rehearsals and shows do not give the old impression of overcrowding.

Scenery shifting, by the way, has been greatly facilitated by the recent provision of the new sliding doors to the main studio at Alexandra Palace. These doors go nearly up to the ceiling.

Another interesting development which has recently come about at the Palace is the building up of scenery mostly in sections. (This not only

carpenters' shop which is situated in what was, I believe, the vestibule of the old Alexandra Palace theatre. Some idea of the extent of the work now undertaken will be gathered from the fact that as many as a dozen people—carpenters, scene painters and the like are employed whole time. Scenery, in fact, seems to be playing an increasingly prominent part in the television programmes, and some interesting experiments have been made.

* * *

The present studio methods still favour scenery painted exclusively in blacks, greys and whites, for it has been established without much doubt that this colour scheme gives the best background effect. Quite recently an effort was made to restrict the costumes of television artists to the same colours, but the experiment was quickly terminated as a complete failure. It needs no imagination to understand that a pretty girl being televised in grey and white clothes, which have the televised appearance of being dirty, gives an effect on the screen which can only be described as deplorable. This, however, was only an experiment and has now been abandoned in favour of clothes for artists embodying the whole spectrum of colour.

This development has resulted in a new branch of activity for Mary Allan, the make-up expert. It is now one of her responsibilities at the Palace to see that the tone colours of studio ensembles are harmoniously correct. She is forever making tests for colour in order to try out the effects of new materials, and has established herself in a new office near the wardrobe.

A great many of the dresses now seen on the television screen are actually made at the Palace, and here again some idea of the amount of work can be estimated from the fact that there are two wardrobe assistants in addition to the two make-up assistants, and the sewing machine can be heard going most of the day.

I was rather surprised to learn that Peter Bax, the well-known stage



Elisabeth Cowell on her recent holiday. "The only brunette in Denmark."

makes scenery shifting much easier, but it makes the material itself far more versatile than hitherto.

Peter Bax, as readers know, is the presiding genius of scenery at A.P., and his work in this important matter is having far-reaching results on the whole character of the shows now being broadcast. A considerable proportion of the scenery is now in sections, and is put together in a manner reminiscent of an expanding bookcase: it is all like playing a game with huge bricks!

All the scenery used at the Palace is made on the premises in the

manager at the Palace, designs many of the dresses which viewers see. It seems to be part of his general plan to harmonise dresses and scenery in television productions, and the same idea seems to be evident in D. H. Munro's productions of ballet.

Those who remember with delight Mr. Munro's productions of the de Basil's "Ballet Russes" some time ago, will look forward to his next effort in this direction on October 11, when he is producing the Vic Wells ballet.

During the last ten years practically every branch of entertainment has received a tremendous fillip in its evolution, and the extension of public interest in it, as a result of radio and the gramophone. But alone among all these varieties of entertainment the ballet has been accorded no such assistance until now. Television, undoubtedly, will have a remarkable quickening effect upon the general appreciation of ballet, and it is gratifying to see that the B.B.C.'s producers are really taking special pains to make the most of the new medium for this purpose.

So far as I am able to judge, D. H. Munro's balletic efforts up to now have been distinguished mostly for the excellence of the lighting effects. It may not be out of place here to mention that one of the chief difficulties between the old classic ballet and the later Fokine and still more recent schools is the effort at complete harmony of movement, colour and music. It seems that with the attention now being given to this essential artistic harmony in tele-

vision production, viewers may soon enjoy some really outstanding ballet.

Reggie Smith, whom I first heard of about two months ago as a stage manager at A.P., has now been promoted to the position of Director of Television Variety. Those who have been watching his work with enthusiasm will be glad to hear of this. Reggie is a big, jolly fellow, every inch an actor. He has, I believe, played everything except principal boy in pantomime. Incidentally, he still makes noises off when required!

Reggie has an evident genius for presenting small floor shows, several of which recently have been a valuable contribution to the entertainment level of the broadcasts.

The latest recruit to the productions staff is Philip Dorté, who comes from the film world. He is now collaborating with Dallas Bower in arranging the film transmissions from Pinewood and Denham, which are to take place between September 30 and October 5. There will be ten of these transmissions in all, and during the five days the television flying squad will be encamped at the studios. The radio link, of course, will be used for transferring the material to the Palace prior to re-diffusion in the ordinary way.

These programmes will make television history, as it is the first occasion that television cameras have been taken to the film studios, and in addition to all the famous film personalities to be seen by viewers a

number of behind the scenes type of programmes will be broadcast as well.

Stephen Thomas at present seems to be concentrating largely upon period programmes, but his recent highly successful efforts at dramatising songs deserves more than a passing mention. In his "Mizzen Crosstrees," which was broadcast on four occasions but with different songs, he showed us an excellent idea in studio technique which suggests considerable scope. Behind the singer he had a moving film background of angry sea which conferred a most realistic atmosphere. Then in his "Old Kentucky" we saw another instance of effective pictorial backgrounds to the real negroes chanting Southern songs.

Harry Pringle hit the bull's-eye with the third and last edition of "Cabaret Cruise," and I must not forget to mention that the peripatetic Leslie Mitchell braved the fire escape once again in "Fire Up Aloft," and would have jumped into the waiting blanket below had it not been that the authorities refused. So a lusty fireman was seen on the screen doing the daring deed instead.

And what is happening to Jasmine Bligh, the television hostess-announcer? Every day and in every way Miss Bligh is getting blonder and blonder—haven't you noticed it? But it is all according to plan, as I was secretly assured the other day, for it has now been decided that the announceresses, in their colouring, must contrast effectively with each other.

Book Review

Television Engineering, by J. C. Wilson. 490 pp. 276 figs. including plates. Sir Isaac Pitman & Sons, 30s. net.

Contents: Historical; The Eye and Optics; Scanning Methods; Analysis of Finite Aperture Scanning Methods; Photo-sensitivity; Amplifiers, Channels and Filters; Light Modulation; Cathode-rays; Synchronising; Special Television Methods.

After Mr. Myers' "Television Optics" comes Mr. Wilson's book with the above title. Messrs. Pitman are among the leading publishers in the production of books on the comparatively new science.

The author, Mr. Wilson, has wisely

devoted the opening chapters to an account of the earlier mechanical processes and the theory underlying them. Two excellent tables on p. 48 give a résumé of all the various invented systems of scanning and re-constitution, orthodox and unorthodox, and should be consulted by all would-be inventors of new systems.

In a description of unorthodox scanning methods we read: "that form of scanning variously known as intercalated, interlaced, intermeshed, interdigitated, interleaved, interwoven, imbricated, poly-ply, multi-mesh, non-sequential, skipping-line or laminular."

The book is written for television engineers, and those who are starting the study of the subject from the beginning would do well to brush up their mathematics if they are to fol-

low all the steps in the formulae. There are one or two minor misprints, such as the negative sign in front of the γ at the foot of p. 260 and the attribution of the telepantoscope to Castellain instead of Castellani.

A most valuable feature is the list of references at the end of each chapter, which enable the reader to obtain further details on any aspect of the subject outlined in the book. These references combined with the thorough survey of the subject which Mr. Wilson has made will place the book as a standard of reference for many years to come. A number of special television engineering courses will be commencing in the technical schools shortly and teachers and students alike will do well to purchase this book.

German :: Japanese :: N.B.C. Programmes

vious recipe it is going to be a very good programme indeed. One of the mainstays of this programme is Florence George, who is the vocalist to Lanny Ross and to Raymond Paige and his Orchestra. Barry McKinley has another 15 minutes from 11.15 p.m. on October 8. There is also Lucille Manners, who has 30 minutes to herself at 1 a.m. on the same day.

As usual, Saturday is one of the most lively of the week. First of all, from W2XAD can be heard the "Melody Men" at 4.45 p.m. At 5 p.m. there are the Continentals, while during the evening can be heard the Escorts and Betty, Your Host is Buffalo, Golden Melodies, Week-end Revue, Alma Kitchell, the well-known contralto, finishing with El Chico, a Spanish revue, at midnight. These notes give a fairly good idea as to the wealth of entertainment to be heard through the Schenectady group of stations through October.

Here are some more fine programmes sponsored by the National Broadcasting Company and broadcast through their international station, W3XAL, in Bound Brook. This station operates on 16.8 metres from 2 p.m. until 2 a.m. and on 49.1 metres from 2 a.m. until 6 a.m. for those who care to listen. On Sunday, October 17, I notice that they have the Green Brothers with their Novelty Orchestra, at 4.30 p.m. This programme is being transmitted to Europe via a special directional beam aerial. At 5.20 there is to be the Southernaires, a negro quartet. Gerry Belcher relates some of his interviews at 6.30 p.m., while Milton Cross introduces the Magic Key of R.C.A. at 7 p.m. There is to be a half-hour of romantic melodies at 9 p.m., while, in direct contrast, do not miss Fish Face and Figg's Bottle, at 9.30 p.m.

On Mondays through this station one of the most popular programmes is



Jane Rhodes is a veteran at 16 for she has been on the air since she was 7 years old. She can be heard over the NBC Red network.

Sweethearts of the Air at 3 p.m., but as this is rather early for most listeners, make a point of hearing Club Matinee at 9.15 p.m. This lasts for 45 minutes and includes Harry Kogen's Orchestra, Robert Gately, and has as supporting vocalists, The Cadet Quartet. The Southernaires have another 15 minutes at 10.45 p.m., while a most comprehensive international news bulletin winds up the day at 11.30 p.m.

For those who are able, tune in to the Breakfast Club at 2 p.m. each weekday. Bob Brown is Master of Ceremonies, while the old favourites, Annette King, contralto, and baritone Jack Baker, are in support. Three good programmes come in a run on October 19, starting at 4 p.m. There are the Honeymooners, Three Majors, followed by a snappy musical programme. At 5.15 Grace and Scotty have 15 minutes, while a new listing entirely is Jack Meakin in Springtime at 11 p.m.

On October 20 there is a special treat at 7.45 p.m. Peggy Wood has 15 minutes all to herself and is arranging a new type of musical programme.



One of the most popular NBC dramatic actresses is Frances Carlon who can be heard in the Story of Mary Marlin.

This is followed by Continental Varieties at 8.30 p.m., introducing for the first time, Celia Branz.

Harry Kogen's Dinner Music is very popular and he has now graduated to a 30-minute session starting at 11 p.m., October 20. The National Farm and Home Hour, which is on the air at 5.30 p.m. every weekday, has, on October 21, a special Guest Speaker from the American Post Office Department, who will give some information on the Police Department which is incorporated in the Post Office service. In America anybody who demands money or tries to do any swindling and writes letters about it can be put in prison for using the Federal Mails for the purpose of fraud. How this all works out is going to be told in this programme. At 8.45 on October 21 a programme

entitled Swing Serenade is listed, followed by Jackie Heller, who has recently broadcast in the Five Hours' Back programme, at 9.15 p.m. Baritone Stuart Gracey, makes his debut at 10.15 on this day, followed by the Kings Men



Florence George is star vocalist in Raymond Paige's orchestra.

Quartet at 10.45, and some more of Harry Kogen's Dinner Music at 11 p.m.

A new type of musical programme is scheduled for 7.15 p.m. on Saturday, October 23, while also on that day can be heard Club Matinee at 9.15, the Little Variety Show, at 10.15, and Nickelodean at 11 p.m. This is an orchestral programme with a host of guest artists.

At the present time, as reception conditions have so greatly improved, make a point of fully testing the scope of your short or all-wave receiver. Programmes from Tokyo on its 19-metre channel are being consistently received in this country, and although they are hardly of entertainment value, they represent a distinct novelty and for those who have not heard the Japanese idea of entertainment now is a good chance to find out.

Programmes from Tokyo are receivable at great strength owing to the fact that special aerials are being used to concentrate the signal into Europe. Actually, I believe, the focal point is Berlin, and as we are in the same direction, obtain the full benefit of this. All Zeesen stations have now increased their power and can be heard almost 24 hours a day. The best programmes, as far as we in this country are concerned, can be received during the latter part of the evening when the station is used with an aerial beamed on New York and programmes are picked so that they are acceptable to the American listeners.

War news, by that I mean the Spanish war and not the Japanese one, can still be heard from Tenerife and Valencia, both on 40 metres.

New Valves for Television and Radio Constructors

WHILE it is possible to obtain results from a short-wave receiver using ordinary valves, gain can be greatly increased when the inter-electrode capacities are reduced to a minimum with a corresponding high mutual conductance.

Some new valves introduced this season for radio and television constructors have extremely fine constants so that the gain per stage can be greatly increased by their use.

For radio and video frequency stages there is an AC-SP₃ which is a high slope screened pentode. With an anode voltage of 250 and a screen voltage of 100 the slope is no less than 10 ma/V. which enables a higher gain to be obtained than with the normal type of valve. The grid/anode capacity is .005 mmfd. while the valve is priced at 15s.

A New Diode

Most double diodes have too high a self capacity for use in vision frequency amplifiers. A special diode type D₁ has been introduced by Mazda which has been designed to have a low minimum capacity by bringing out the electrode connections to short pins sealed directly into the glass.

Connections are made by hanging the valve directly in the wiring of the receiver. As with most midget type of valves connections to the D₁ diode should not be soldered, but made by crocodile clips.

A new thyratron filled with mercury vapour instead of gas has been designated the T₁₁. This valve can withstand a much heavier peak current than the well-known T₃₁ which is to be preferred in conventional scanning circuits.

A British valve having characteristics similar to the American 6L6 has also been introduced by Mazda. This valve, the AC₄/PEN, is intended for use in broadcast receivers where a high audio output is required. The valve is a tetrode in which the secondary emission from the anode is suppressed by the space charge of the anode current. The absence of a suppressor grid enables the valve to be used more efficiently and with decreased harmonic distortion. The characteristics of this valve are approximately as follows:—

- Heater volts, 4.0
- Heater current, 1.75
- Anode volts (max), 250
- Screen volts (max), 250
- Dissipation (max), 16 watts
- Mutual conductance, 11

The AC₄/PEN will give an audio output of 8 watts and requires a bias resistor of 100-ohms. The anode load for this output is 3400-ohms, while the

total cathode current is 77 M/a with a grid drive of 4.3 volts.

A very similar valve for AC or DC operation is the PEN.DD4021 which also includes a double-diode section. Constructors of short-wave receivers will welcome the introduction of the Mazda AC/TH₁, a triode-hexode frequency changer having a conversion conductance of 870. Owing to the



Particularly robust construction is employed in the Mazda beam power tetrode type AC₄/PEN.

special design of this valve it is suitable for use on ultra-short waves.

A special triode for scanning circuits has been called the AC/P₄. This valve has a slope of 7 M/V with an anode voltage of 600. It is fitted with a top cap connection to which the anode is taken and needs a bias resistor of 11,000-ohms.

Owing to the demand for output valves giving a high speech output with low voltage the Tungsum Electric Lamp Works have designed two new pentode valves that give an output in excess of 5 speech watts.

The APP4E with 250 volts on both anode and screen and an optimum load of 3,500-ohms give 5 watts with 5 per cent. harmonic distortion. The output can be increased to 8.8 watts with 10 per cent. distortion. In such circumstances the total cathode current is 80M/a. These valves can be used in push-pull circuits and with a 400 volt supply and an optimum load of 6,500-ohms the output with 5 per cent. distortion is 28.5 watts.

A variation of this valve is the PP6E which has almost identical characteristics but is fitted with 6.3 volt heater. Under class A conditions the maximum

output is 8.8 watts, while two valves in push pull with 300 volts will give 19.5 watts.

Cossor have designed a complete new range of output tetrodes. These new valves have the normal characteristics of conventional pentodes so that they are interchangeable, but due to a lower grid anode-capacity and lower impedance, attenuation of the higher frequencies is reduced, while bass resonance is not so noticeable. The result of using these tetrodes is greatly improved quality and in many instances greater output.

The battery tetrode type 220.OT priced at 11s. has a 2-volt.2-amp. heater and requires a maximum of 150 volts on both anode and screen.

A mains version type 42.OT with a 4-volt 2-amp. heater is priced at 13s. 6d. and this valve has a slope of 7 ma/V and requires 250 volts on both anode and screen. In the DC.AC. range there is the 402.OT with a 40-volt 2-amp. heater, but otherwise characteristic similar to that of the 42.OT.

Transmitting amateurs will appreciate the following data on a new pair of beam power type tetrodes suitable for oscillator, doubler and amplifier positions in a transmitter. The anode lead is brought out to a separate seal at the top of the bulb to reduce inter-electrode capacities, while the bases are of isolantite.

These valves, the RK39 and RK41, are almost identical in characteristics except that the RK41 has a 2.5 volt heater and the RK39 a 6.3 volt heater. They can be operated at full voltage of 500 up to 30 megacycles and at lower voltages up to 60 megacycles. Cathode bias is recommended to protect the valve in the case of excitation failure and a resistance of 400 or 500 ohms will be satisfactory.

When used with a crystal oscillator a 400-ohm cathode resistor and 10,000-ohm grid leak are required. At lower frequencies it may be necessary to introduce slight external capacity in order to start oscillation, but this capacity should not exceed 2-mmfd.

The following are typical operation figures:—

- Maximum anode voltage, 500
- Maximum screen voltage, 250
- Control grid voltage, 60
- Anode current, 95 M/a
- Screen current, 12 M/a
- Grid current, 3 M/a
- Maximum R-F input, 84 volts
- Grid driving power, .26 watts
- Carrier output, 35 watts.

These valves are available from Messrs. Webbs' Radio, Ltd., 14 Soho Street, W.1.

Triodes and Pentodes for Transmitting

Short-wave enthusiasts were quick to realise the advantages of the new valves introduced by the General Electric Co., Ltd. Of these the PT5 transmitting pentode and the DET12 triode are of particular use to amateurs. The PT5 is a directly heated pentode that can be used as an oscillator, a radio-frequency amplifier or doubler. It is arranged with the anode to the top cap



Notice the new Octal base with 8 pins and a locating key on this new Marconi W63 pentode which is the equivalent of the American 6 K7G.

and has the conventional 5-pin base. Characteristics are approximately as follows:

- Filament volts, 4.0.
- Filament current, 1.7 amp.
- Anode volts, 1,250 max.
- Screen volts, 300 max.
- Anode current, 32 mA.
- Screen current, 6 mA.
- Anode Dissipation, 40 watts max.
- Screen dissipation, 10 watts max.
- Mutual conductance, 4.0 mA./volt.

As can be seen from these characteristics, the valve is ideal for use in the average amateur transmitting circuits, and can give, under suitable conditions, a very high radio-frequency output. The inter-electrode capacities are approximately as follows:

- Anode-grid, 0.03 mmfd. approx.
- Anode to others, 15.2 mmfd. approx.
- Grid to others, 24.5 mmfd. approx. (measured with external shield).

The price of this valve is £8 5s. od., which, without consideration, may ap-

pear to be a trifle high, but when one considers the low cost of the modulator, the small amount of drive required, and the fact that it is suitable for multi-band operation with the minimum number of stages, it is good value for money.

A New Triode

Another new Osram valve is the DET12 triode which is a carbon-anode type with anode and grid brought out to top connections. It has a standard 4-pin base and with 120 watts input will give between 75 and 80 watts of carrier. It is rated at 50 watts and will operate down to 1 metre. Characteristics are as follows:

- Filaments volts, 7.5.
- Filament current, 3.15 amps.
- Anode volts, 1,250 max. down to 3 metres.
- 1,125 max. down to 2 metres.
- 1,000 max. down to 1½ metres.
- 750 max. down to 1 metre.

- Anode dissipation, 50 watts max.
- Amplification factor, 10.3.
- Impedance, 5,400 ohms.
- Mutual Conductance, 1.9 mA./volt.

A neutralising condenser of approximately 4 mmfd. is required, while the inter-electrode capacities are approximately as follows:

- Anode-filament, 0.8 mmfd. approx.
- Grid-filament, 2.4 mmfd. approx.
- Anode-grid, 2.6 mmfd. approx.

The price of this valve is £6 13s. 6d. Constructors interested in ultra-high frequency work will appreciate the new ZA1 low-capacity Acorn pentode with indirectly heated cathode. It is designed for operation from 4-volt A.C.

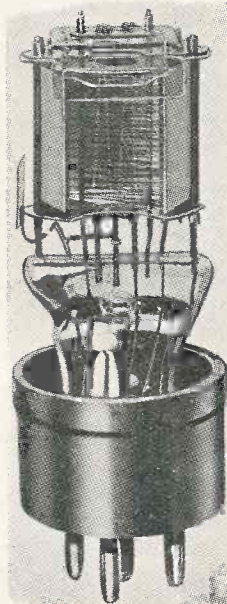

Marconi have introduced a new range of output tetrodes. This is one of the 2-volt battery operated type.

or D.C. supply, consuming approximately .25 ampere. It will handle a maximum anode voltage of 250, maximum screen voltage of 100, and has a slope of 1.4 mA./volt. The anode to grid capacity is approximately .001-mmfd. The price of this valve is £3.

In the Marconiphone range there are a number of new valves of particular interest. Amongst the most outstanding are the X22 battery operated heptode, which is suitable for use down to 12 metres, a W21 battery operated pentode, the KT21 output tetrode, and a KT42 output tetrode for A.C. operation. In the International range is a new tuning indicator type Y63 and a heptode type X64 in which pulling between oscillator and signal circuits is negligible. A special frequency

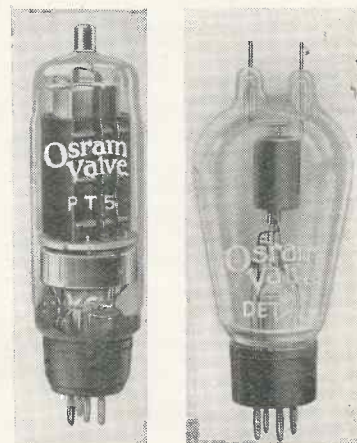

On the left is the new PT5 transmitting pentode suitable for amateur use. On the right is a triode valve with carbon anode and very low inter-electrode capacity. The type number is DET12.

changer for use down to 15 metres is the new X63, while a large output tetrode is the KT66. This valve, with 250 volts on both anode and screen, will give 8 watts of audio, or two valves in Class AB will give 35 watts of audio with 400 volts on the anodes.

For transmitting amateurs there is the 25-watt pentode type DET8, which is suitable for suppressor grid modulation and can be used down to 15 metres. The maximum anode voltage is 400, while a 4-volt 2-amp heater is employed.

In Tungram valves they use no less than 60 different materials plus seven different gases, and 35 other elements which enter into the manufacture. These interesting details were noted while we were examining their new frequency changer type TX4. This valve will handle a maximum anode voltage of 300, has a 4-volt 1-amp heater and is suitable for use as a frequency changer on short waves, and is, of course, of the triode-hexode type.



*from the most
comprehensive range
of*

CATHODE RAY TUBES

Since 1902 Cossor research in the design and practice of Cathode Ray Tubes has always kept ahead of the times. As a result to-day Cossor have available a comprehensive range of Cathode Ray Tubes second-to-none.

Cossor research in the field of Television too, has proved eminently fruitful, and results have amply justified their pioneer work in the use of Cathode Ray Tubes for Television. Progress in this sphere has brought about many types but the Cossor full range of tubes is admitted as being unparalleled in respect of quality, focus and brilliance.

A request for leaflet L.213 to Instrument Dept., A. C. Cossor Ltd., Highbury Grove, London, N.5, will bring full details and data of the range available.

from the
'WIRELESS WORLD'
Editorial 2.4.37.

•

"It was not until about thirty years later that the cathode ray tube came to be regarded as an every day instrument in the laboratory, although as long ago as 1902 Cossors, the valve manufacturers, were producing their first examples."

COSSOR

CATHODE RAY TUBES

A. C. COSSOR LTD., HIGHBURY GROVE, LONDON, N.5

1/3032